



2020 / 2021





Mutfağın tüm renkleri...

All colours of the kitchen...

KAPP ÜRETİM TESİSLERİ MANUFACTURING FACILITIES





İçindekiler

Pişirme



1

11/12	Düdüklü Tencere	28/29	Tencereler Döküm
17/18	Silindirik Tencereler	30	Tavalar Döküm
19	Kapaklar	31	Kızartma Örtüsü Çelik Fırın Tepsileri
20	Helvane Tencereler		
21	Makarna Pişirme Süzgeç		
21	Kuskus Süzgeci		
24	Tavalar		
25	Kaçarola		
26	Tavalar (Alüminyum		
27	Teflon)		

Hazırlık



2

36/41	GN Küvetler	60	Konserve Açacağı	69	Sos Hunisi	72	Kevgir
43	PC Saklama Kapları	60	Ekmek Kesim	69	Sipariş Tutucu	72	Tencere Teli
44	Küvetler (Bain Marie)	60	Hamburger	69	Şef Cımbızı	72	Tava Teli
45	PP Saklama Kapları	61	Şekillendirici	70	Şaşula	73	Çırpıcı
47	GN Ekipmanları	61	Makaslar	70	Elek	74/75	Spatulaları
50/51	PC Küvetler	62	Sarmısak Ezici	70	Kalbur	75	Pizza Ruleti
53/54	Sebze Kurutucu	62/63	Parizyen Kaşıkıar	71	Süzgeç	76	Hamur Kazıyıcısı
55	Japon Tornası	64/65	El Aletleri	71	Çin Külalı	76	Kesim Levhaları
56	Mandolin Kesme	66	Termometreler	71	Konik Süzgeç	76	Kesim Levhası İstif Teli
57	Ananas Soyma	67	Teraziler	71	Süzgeç Makarna	78/84	Bıçaklar
57	Patates Dilimleme	67	Ölçülü Kaplar	72	Huni (Süzgeçli)	85	Et Çengeli
58/59	Sebze Doğrayıcı	68	Ölçek Seti	72	Derin Kepçe	85	Çelik Eldivenler/Önlük
60	Püre Makinesi	68	Rendeler	72	Tel Süzgeç	85	Bıçaklık Miknatıslı Bıçak Sterilizatörü

Pastacılık



3

88/90	Yapışmaz Kalıplar	101	Kabartma Kabı
90	Silpat Fiber Örtü	102	Krema Torbası
91/95	Silikon Kalıplar	102	Duy Set
96/97	Çikolata Kalıpları	102	Pürmüz
98	Çikolata Ekipmanları	103	Kruvasan Merdane
99	Paslanmaz Çelik Kalıplar	103	Polı Merdane
100	Volovan	103	Pandispanya Testeresi
100	Rulet	105	Pasta Standı
101	Yanmaz Eldiven	106/107	Spatulalar
		107	Hamur Kazıyıcısı

Servis



4

110	Kaydırmaz Tepsiler	117	PC Kaşık Servis
110	Tepsi Kırçılı	117	PC Kepçe/Maşa
110/111	Servis Tepsi	119	Şef Cımbızı
112	Self Servis Tepsi	119	Kaşık Dekor Seti
113	Kepçeler	120	Kaşık Standı
113	Kevgirler	120	Dondurma Kaşığı
115/116	Servis Pilav	120	Pilav Ölçeği
115	Kaşıklar	120	Patates Küreği
116	Servis Çatalı	121	Sos Dispenserleri
115/117	Servis Spatula	121	Sos Şişeleri
117	Silikon Maşalar	121	Sos/Şurup Dökücü

Açık Büfe



5

124/129	Vega Chafing Dish	154	Servis Üniteleri
131/137	Carina Chafing Dish	155	Carving Station
139/141	Premium Chafing Dish	156/157	Açık Büfe Standları
142/144	Delux Chafing Dish	158	Açık Büfe Sunumluklar
145	Klasik Chafing Dish	159	Açık Büfe Yükselticiler
146	Ekonomik Chafing Dish	159	Açık Büfe Yükselticiler
146	İsimlik	160/161	Kayrak Sunumluklar
146	Kaşık/Kepçe Standı	162	Sunum Tepsileri
147	Chafing Dish Küvetler	163	Ekmek Sepetleri
149/151	Dispenserler		
152/153	Sıcak Tutucu Lambalar		

Restaurant

6

- | | | | |
|---------|-----------------------|-----|-----------------|
| 168/169 | Kayrak Sunumluklar | 179 | Kaseler |
| 170 | Ahşap Sunumluklar | 179 | Dondurmalık |
| 171 | Tabaklar PC | 180 | Ekmek Sepetleri |
| 173/176 | Tuzluk & Karabiberlik | 181 | Küllükler |
| 177 | Yağlık & Sirkelik | | |
| 179 | Kırıntı Küreği | | |
| 179 | Peçetelikler | | |
| 179 | Sunum Kapakları | | |
| 179 | Sos Teknesi | | |

İçecek

7

- | | | | |
|---------|-----------------------|---------|----------------|
| 184 | İçecek Makineleri | 190/191 | Buz Makineleri |
| 185 | Sıcak Çikolata | 192/193 | Dispenserler |
| 186 | Dondurma Makinesi | 194 | Termos |
| 186 | Buzlu İçecek Makinesi | 195 | PC Bardaklar |
| 187/188 | Blenderlar | | |
| 189 | Narenciye Sıkacağı | | |
| 188 | Buz Kırıcı | | |
| 188 | İçecek Mikseri | | |

Bar

8

- | | |
|---------|---------------------------|
| 198 | Buz Kovaları |
| 200 | Şampanya & Şarap Kovaları |
| 201/202 | Bar Ekipmanları |
| 202 | Soda Sifonu |
| 203 | Çerezlikler |
| 204 | Tepsiler Kaydırmaz |
| 205 | Küllükler |

Ekipmanlar

9

- | | | | |
|---------|------------------------|---------|--------------------|
| 208/211 | El Tipi Blenderlar | 232 | Mikrodalga Fırın |
| 212 | Sebze Doğrayıcı | 233 | İndüksiyon Ocaklar |
| 213 | Dilimleyici Bıçaklar | 234/235 | Blenderlar |
| 217 | Peynir Rendeleyici | 237 | Narenciye Sıkacağı |
| 218/223 | Gıda Dilimleyici | 238/239 | Buz Kırıcı |
| 224/225 | Planet Mikser | | |
| 226/227 | Et-Kemik Testeresi | | |
| 228 | Vakumlu Paket Makinesi | | |
| 230/231 | Soft Cooker | | |

Taşıma

10

- | | |
|---------|------------------|
| 242 | Taşıma Kovaları |
| 243 | Sefer Tasları |
| 243 | Taşıma Tepsisi |
| 244/246 | Thermobox |
| 247/248 | Servis Arabaları |
| 250/251 | Taşıma Arabaları |
| 252/253 | Rafılar |

Bulaşık

11

- | | |
|---------|-------------------|
| 256/261 | Basketler |
| 256/261 | Yükselticiler |
| 262 | Sinek Öldürücüler |
| 263 | Bulaşık Yıkama |
| 263 | Evye |
| 263 | Çöp Kovası |

Index

Cooking



1

11/12	Pressure Cooker	28/29	Tavayar Cast Iron
17/18	Stock Pots	30	Roasteasy
19	Lids	31	Roasting Pans
20	Wide Shallow Pots		
21	Colander Pasta		
21	Colander Couscous		
24	Pans		
25	Sauce Pan		
26	Pans (Aluminum Non-Stick)		
27	Pots Cast Iron		

Preparing

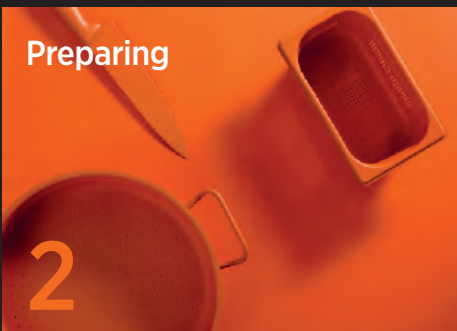

2

36/41	GN Food Pans	60	Can Opener	69	Tickets-Holder	72	Strainer For Pan
43	PC Storage Containers	60	Bread Cutting Board	69	Chef's Tong	72	Whisk
44	Containers (Bain Marie)	60	Hamburger Press	69	Scoop	73	Spatulas
45	PP Storage Containers	61	Scissors	70	Sieve	74/75	Pizza Roulette
47	GN Equipments	61	Garlic Press (S/S)	70	Grate	75	Dough Scraper
50/51	PC GN Pans	62	Melon Ballers	70	Colander	76	Cutting Boards
53/54	Salad Spinner	62/63	Kitchen Utensils	71	Chinese Colaner	76	Board Scraper
55	Turning Slicer	64/65	Thermometers	71	Conical Strainer	76	Cutting Board Rack
56	Mandoline	66	Scales	71	Colander Pasta	78/84	Knives
57	Pineapple Peeler	67	Calibrated Cups	71	Funnel w/Strainer	85	Meat Hook
57	French Fry Cutter	67	Measuring Cup Set	72	Round Strainer	85	Chain Gloves/Apron
58/59	Fruit/Vegetable Cutter	68	Graters	72	Skimmer	85	Magnetic Board
60	Food Mill	68	Sauce Gun	72	Strainer For Pot	85	Knife Sterilizer

Pastry



3

88/90	Moulds Nonstick	101	Cream Whipper
90	Baking Sheet Silicone	102	Pastry Bags
91/95	Silicone Moulds	102	Icing Tip Big Set
96/97	Chocolate Moulds	102	Torch
98	Chocolate Equipments	103	Croissant Roller Cutter
99	Stainless Steel Moulds	103	Poli Roller
100	Cutter	103	Ganoese Saw
100	Pastry Rollers	105	Cake Stand
101	Oven Mitt	106/107	Spatulas
		107	Dough Scraper

Serving



4

110	Non-slip Trays	117	PC Spoon Serving
110	Textured Tray	117	PC Ladle/Tong
110/111	Serving Tray	119	Chef's Tong
112	Self Service Trays	119	Spoon Set Decor
113	Ladles	120	Spoon Rest
113	Skimmers	120	Ice Cream Spoon
115/116	Service Spoons	120	Rice Scoop
115	Serving Forks	120	French Fries Shovel
116	Turner Perforated	121	Sauce Dispensers
115/117	Serving Utensils	121	Sauce Bottle
117	Silicone Tongs	121	Pouring Container

Open Buffet



5

124/129	Chafing Dish Vega	154	Buffet Plates
131/137	Chafing Dish Carina	155	Carving Station
139/141	Chafing Dish Premium	156/157	Buffet Service Stands
142/144	Chafing Dish Deluxe	158	Display Plates
145	Chafing Dish Classic	159	Unbreakable Displays
146	Chafing Dish Economic	159	Buffet Service Elevators
146	Name Tag	160/161	Slate Display Plates
146	Spoon Rest	162	Display Trays
147	Chafing Dish Food Pans	163	Bread Baskets
149/151	Dispensers		
152/153	Heat Retaining Lamps		

Table-Top

6

- | | | | |
|---------|----------------------|-----|---------------|
| 168/169 | Slate Display Plates | 179 | Bowls |
| 170 | Wooden Displays | 179 | Ice Cream Cup |
| 171 | Plates PC | 180 | Bread Baskets |
| 173/176 | Salt & Pepper | 181 | Ashtrays |
| 177 | Condiment Sets | | |
| 179 | Table Crumbler | | |
| 179 | Napkin Holders | | |
| 179 | Display Covers | | |
| 179 | Gravy Boat | | |

Beverage

7

- | | | | |
|---------|-------------------------------|---------|---------------------------|
| 184 | Juice Cooler | 190/191 | Ice Makers |
| 185 | Hot Chocolate Dispenser | 192/193 | Dispensers |
| 186 | Granita & Ice Slush Dispenser | 194 | Insulated Beverage Server |
| 186 | Ice Slush Dispenser | 195 | Glasses PC |
| 187/188 | Blenders | | |
| 189 | Citrus Juicer | | |
| 188 | Ice Crusher | | |
| 188 | Beverage Mixer | | |

Bar

8

- | | | | |
|---------|--------------------------|--|--|
| 198 | Ice Buckets | | |
| 200 | Champagne & Wine Buckets | | |
| 201/202 | Bar Equipments | | |
| 202 | Soda Siphon | | |
| 203 | Appetizer Displays | | |
| 204 | Trays Non-slip | | |
| 205 | Ashtrays | | |

Kitchen Appliances

9

- | | | | |
|---------|--------------------------|---------|-------------------|
| 208/211 | Blenders | 232 | Microwave Oven |
| 212 | Vegetable Cutter | 233 | Induction Cookers |
| 213 | Discs | 234/235 | Blenders |
| 217 | Cheese Grater | 237 | Citrus Juicer |
| 218/223 | Slicer | 238/239 | Ice Crusher |
| 224/225 | Planet Mixer | | |
| 226/227 | Bone Saw | | |
| 228 | Vacuum Packaging Machine | | |
| 230/231 | Soft Cooker | | |

Carrying

10

- | | | | |
|---------|--------------------------|--|--|
| 242 | Carrying Containers | | |
| 243 | Portable Food Containers | | |
| 243 | Carrying Tray | | |
| 244/246 | Thermobox | | |
| 247/248 | Service Trolleys | | |
| 250/251 | Carrying Trolleys | | |
| 252/253 | Shelves | | |

Dish Washing

11

- | | | | |
|---------|----------------|--|--|
| 256/261 | Racks | | |
| 256/261 | Extenders | | |
| 262 | Insect Killers | | |
| 263 | Dish Washing | | |
| 263 | Sink | | |
| 263 | Rubbish Bin | | |





Piřirme/Cooking

- 1,20 mm kalınlığında 304 kalite paslanmaz elikten imal edilmiřtir
- 3 adet emniyet valfi mevcuttur
- Buhar bořaltma valfi 3 konumdan oluřur: 1. ve 2. konum piřirmede, 3. konum buhar bořaltmada kullanılır
- Kapak paraları soklp takılabilir ve yıkanabilir
- Indiksiyon ocaklara uygundur

- 3 Independent Safety Valves for Security
- Blowoff valve consists of 3 positions
- Innovative Lid with Easy to Use Locking System
- Impact Bonded Sandwich Bottom
- Fast and Efficient Heat Disribution
- Heat Resistant Side Handles
- 18/10 Stainless Steel, 1,20 mm thickness
- Easy Cleaning With Removable Lid Attachments



» Düdüklü Tencere / Pressure Cooker

Kod Code	Øxh (cm) Øxh (cm)	Lt Lt	Koli/Adet Pcs/Ctn
32384025	40x25	32	1
32384030	40x30	37	1
32384040	40x40	50	1

Kod Code	Model Model	Ø (cm) Ø (cm)	Koli/Adet Pcs/Ctn
35700040	Düdüklü Tencere Kapak / Pressure Cooker Lid	40	1
30210140	Konvex Kapak / Convex Lid	40	1
35700155	Silikon Kapak Contası / Silicone Seal	40	1





12

» Düdüklü Tencere / Pressure Cooker

Kod Code	Øxh (cm) Øxh (cm)	Lt Lt	Koli/Adet Pcs/Ctn
32383219	32x19	15	1
32383223	32x23	18	1
32383230	32x30	23	1

Kod Code	Øxh (cm) Øxh (cm)	Ø (cm) Ø (cm)	Koli/Adet Pcs/Ctn
35700032	Düdüklü Tencere Kapak / Pressure Cooker Lid	32	1
30210132	Konvex Kapak / Convex Lid	32	1
35700154	Silikon Kapak Contası / Silicone Seal	32	2



- 1,20 mm kalınlığında 304 kalite paslanmaz elikten imal edilmiřtir
- 2 adet emniyet valfi mevcuttur; 1. valf aılmadıđı takdirde, 2. valf devreye girer
- Buhar bořaltma valfi 3 konumdan oluřur: 1. ve 2. konum piřirmede, 3. konum buhar bořaltmada kullanılır
- Kapak paraları soklp takılabilir ve yıkanabilir
- İndüksiyon ocaklara uygundur

- 2 Independent Safety Valves for Security
- Blowoff valve consists of 3 positions: 1. and 2. position is for cooking, 3. position is for blowoff
- Innovative Lid with Easy to Use Locking System
- Impact Bonded Sandwich Bottom
- Fast and Efficient Heat Distribution
- Heat Resistant Side Handles
- 18/10 Stainless Steel, 1,20 mm thickness
- Easy Cleaning With Removable Lid Attachments





- KAPP stands out with “IMPACT BONDED” three layer sandwich bottom in all lines and sizes.
- KAPP is the only brand which offers “induction ready” cookware in ALL sizes.

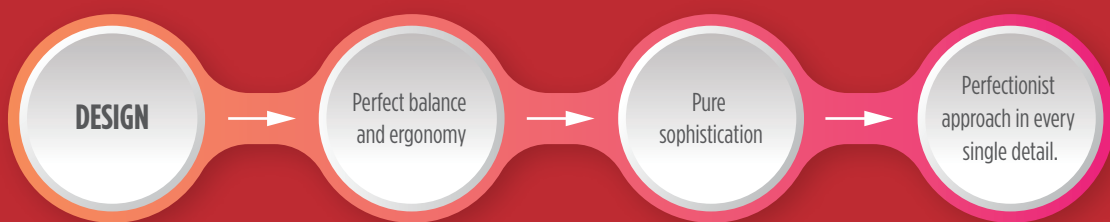

QUALITY

KAPP products are extremely robust. Tried and tested up to the highest standards. By leveraging our strengths in product design, packaging and distribution; we provide unique, innovative solutions for Professional Kitchens

.KAPP products are manufactured by means of attentive production processes and only delivered after strict quality controls.

All the procedures are monitored by our Quality Management System which is certified by TUV, GOST, HACCP and CE internationally.

“The Great Lake Culinary Institute Laboratories” in USA, tested and approved our quality and classified KAPP products within the best quality product ranges in the world.

TEKNOLOJİ VE KALİTE GELENEĞİ



Paslanmaz Çelik
/Stainless Steel
Alüminyum
/Aluminum
Paslanmaz Çelik
/Stainless Steel

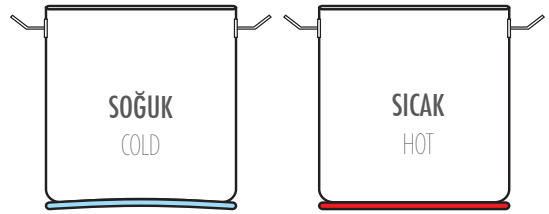

ÇAKMA TABAN / IMPACT BOUNDING

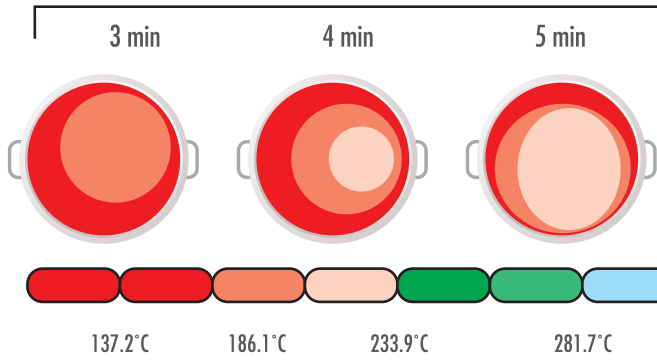

YAPIŞTIRMA TABAN / BRAZED BOTTOM

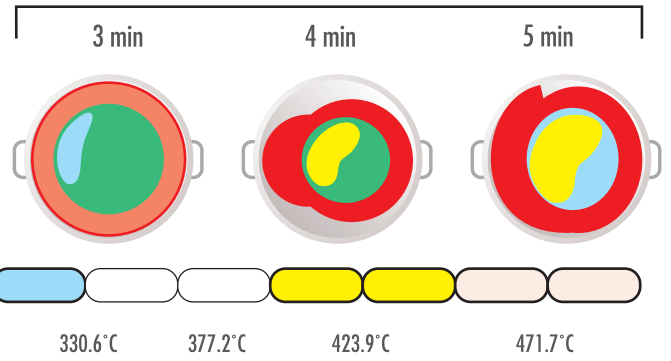

* Tencere tabanı 2500 ton üzerinde kuvvetle çakılmaktadır.

/ Bases are forged bound by over 2500 tons pressure

* %95 oranında saf alüminyum

/ %95 pure aluminum

* Taban saclarında %99 üzerinde birleşme

/ Bottom plates combine chemically over %99

* Yapışma makinesiyle birleştirme

/ Combine with brazing machine

*Normal, saf olmayan alüminyum

/ Standart aluminum, not pure

*3. Katın %55 oranında birleşmesi

/ %55 combining of the 3. Layer



Mükemmel eşit pişirme
Perfect even cooking



Yapışma, yanma ihtimali Değişken ısı
Sticking, burning possibility Variable heat



Yapışma, yanma Yüksek ısı
Sticking, burning High heat

- Ekstra puntalarla güçlendirilmiş saplar dayanıklılığı artırır, en büyük boy tencereler de dahil ağırlıktan kaynaklı bükülme yaşanmaz.

Handles are reinforced with extra durability, there is no weight-induced bending, even in the largest pots.



- Her tencerenin sapında üretildiği tarih yazılıdır. Ürünlerin kalite kontrolü ve takibi mutfaklara girdikten sonra da devam eder. Her tencere 5 yıl garantiye sahiptir.

Each pot has its production date on its handles. Quality control and follow-up of the products continue after entering the kitchens. Each pot has a 5 year warranty.



- "Impact" taban teknolojiyle her ürünün tabanı 5 yıl süreyle Kapp garantisi altındadır.

Every product with "Impact" base technology has under Kapp's guarantee for 5 years.



Silindirik Tencereler / Stock Pots Casseroles



» Derin (Kapaklı) / Jumbo Stockpot (w/lid)

Kod Code	Øxh (cm) Øxh (cm)	Lt Lt	Koli/Adet Pcs/Ctn
30141616	16x16	3,0	4
30142020	20x20	6,3	4
30142424	24x24	10,5	2
30142828	28x28	17,2	2
30143030	30x30	21,2	1
30143231	32x32	26,0	1
30143635	36x36	36,6	1
30144040	40x40	50,0	1
30144544	45x45	70,0	1
30145050	50x50	100	1
30146055	60x55	155,4	1

» Orta Derin (Kapaklı) / Stockpot (w/Lid)

Kod Code	Øxh (cm) Øxh (cm)	Lt Lt	Koli/Adet Pcs/Ctn
30141611	16x11	2,0	4
30141812	18x12	3,0	4
30142017	20x17	5,3	4
30142419	24x19,5	8,8	4
30142823	28x23	14,2	2
30143024	30x24	17,0	2
30143227	32x27,5	22,1	2
30143629	36x29	29,5	1
30144025	40x25	32,0	1
30144032	40x32	40,2	1
30144528	45x28	44,0	1
30145030	50x30	58,0	1
30146035	60x35	99,0	1

» Orta Sığ (Kapaklı) / Deep Casseroles (w/Lid)

Kod Code	Øxh (cm) Øxh (cm)	Lt Lt	Koli/Adet Pcs/Ctn
30141608	16x7	1,4	4
30141809	18x8	2,0	4
30142010	20x9	3,0	4
30142013	20x13	4,1	4
30142214	22x14	5,3	4
30142411	24x10,5	5,0	4
30142415	24x15	6,8	4
30142812	28x12	7,4	4
30142817	28x17	10,5	2
30143012	30x14	12,1	2
30143020	30x20	14,1	2
30143215	32x15	12,1	2
30143219	32x19	15,3	2
30143617	36x17	17,3	2
30143622	36x22	22,4	2
30144019	40x19	25,0	1
30144522	45x22	35,0	1
30145020	50x20	39,0	1
30146025	60x25	70,0	1

17



» Sığ Tencere (Kapaklı) Shallow Casseroles (w/lid)

Kod Code	Øxh (cm) Øxh (cm)	Lt Lt	Koli/Adet Pcs/Ctn
30142210	22x9,5	3,6	4
30142475	24x7,5	3,5	4
30142807	28x7	4,3	4
30143275	32x7,5	6,0	2
30143608	36x8	8,1	2
30144008	40x8	10,0	2
30144510	45x10	15,9	1
30145010	50x10	20,0	1
30146010	60x10	28,3	1

» Çorbalık (Gömmе) Soup Pot (Built-in)

Kod Code	Øxh (cm) Øxh (cm)	Lt Lt	Koli/Adet Pcs/Ctn
35522428	24x28 (Tabanlı/w/base)	12,5	2
35522828	28x28 (Tabanlı/w/base)	17,2	2
35523232	32x32 (Tabanlı/w/base)	26,0	1
35503637	36x36 (Tabanlı/w/base)	36,6	1
35504050	40x40 (Tabanlı/w/base)	50,0	1
35505051	50x50 (Tabanlı/w/base)	100	1
35506055	60x55 (Tabanlı/w/base)	155	1
35522400	24x28 (Tabansız/w/o base)	12,5	2
35522800	28x28 (Tabansız/w/o base)	17,2	2
35523200	32x32 (Tabansız/w/o base)	26,0	1
35503600	36x36 (Tabansız/w/o base)	36,6	1
35504000	40x40 (Tabansız/w/o base)	50,0	1
35505000	50x50 (Tabansız/w/o base)	100	1
35506000	60x55 (Tabansız/w/o base)	155	1



Silindirik Tencereler / Stock Pots Casseroles



» Derin Tencere
Jumbo Stock Pot

Kod Code	Øxh (cm) Øxh (cm)	Lt Lt	Koli/Adet Pcs/Ctn
30311616	16x16	3,0	4
30312020	20x20	6,3	4
30312424	24x24	10,5	2
30312828	28x28	17,2	2
30313030	30x30	21,2	1
30313231	32x32	26,0	1
30313635	36x36	36,6	1
30314038	40x40	50,0	1
30314544	45x45	70,0	1
30315050	50x50	100,0	1
30316055	60x55	155,4	1



» Orta Derin Tencere
Stock Pot

Kod Code	Øxh (cm) Øxh (cm)	Lt Lt	Koli/Adet Pcs/Ctn
30312017	20x17	5,3	4
30312419	24x19,5	8,8	4
30312823	28x23	14,2	2
30313024	30x24	17,0	2
30313228	32x27,5	22,1	2
30313629	36x29	29,5	1
30314032	40x32	40,0	1
30314528	45x28	44,0	1
30315030	50x30	58,0	1
30316035	60x35	99,0	1



» Orta Boy Tencere
Deep Casseroles (w/Lid)

Kod Code	Øxh (cm) Øxh (cm)	Lt Lt	Koli/Adet Pcs/Ctn
30311611	16x11	2,0	4
30311812	18x12	3,0	4
30312013	20x13	4,1	4
30312214	22x14	5,0	4
30312415	24x15	7,0	4
30312817	28x17	11,0	2
30313020	30x20	14,1	2
30313219	32x19	15,0	2
30313622	36x22	23,0	1
30314025	40x25	32,0	1
30314522	45x22	35,0	1
30316025	60x25	70,0	1

18



» Orta Sığ Tencere
Shallow Casseroles

Kod Code	Øxh (cm) Øxh (cm)	Lt Lt	Koli/Adet Pcs/Ctn
30311607	16x7	1,4	4
30311808	18x8	2,0	4
30312009	20x9	3,0	4
30312210	22x9,5	3,6	4
30312411	24x10,5	4,7	4
30312812	28x12	7,4	4
30313015	30x12	10,6	2
30313215	32x15	12,1	2
30313617	36x17	17,3	2
30314019	40x19	25,0	1
30315019	50x20	39,3	1



» Sığ Tencere
Shallow Stew Pan

Kod Code	Øxh (cm) Øxh (cm)	Lt Lt	Koli/Adet Pcs/Ctn
30312475	24x7,5	3,5	4
30312807	28x7	4,3	4
30313208	32x7,5	6,0	2
30313608	36x8	8,1	2
30314008	40x8	10,0	2
30314510	45x10	15,9	1
30315010	50x10	20,0	1
30316010	60x10	28,3	1





» Kapaklar

Lids

Kod Code	Ø (cm) Ø (cm)	Koli/Adet Pcs/Ctn
30212116	16	4
30212118	18	4
30212120	20	4
30212122	22	4
30212124	24	4
30212128	28	2
30212132	32	2
30212136	36	2
30212140	40	1
30212145	45	1
30212150	50	1
30212160	60	1



» Konvex Kapaklar

Convex Lids

Kod Code	Ø (cm) Ø (cm)	Koli/Adet Pcs/Ctn
30210116	16	4
30210118	18	4
30210120	20	4
30210122	22	4
30210124	24	4
30210128	28	2
30210130	30	2
30210132	32	2
30210136	36	2
30210140	40	1
30210145	45	1
30210150	50	1
30210160	60	1



Helvane Tencereler / Wide Shallow Pots

» Tencereler (Kapaklı)

Wide Shallow Pots

Kod Code	Øxh (cm) Øxh (cm)	Lt Lt	Koli/Adet Pcs/Ctn
30013015	30x15	13	4
30013615	36x15	16	4
30013620	36x20	21	4
30014017	40x17	24	3
30014520	45x20	29	2
30015020	50x20	36	2
30015520	55x20	40	2
30016020	60x20	45	2
30016025	60x25	65	1
30016525	65x25	75	1
30017030	70x30	108	1
30018030	80x30	136	1
30019030	90x30	166	1
30010035	100x35	258	1
30011035	110x35	289	1



20

» Helvane Kapaklar

Lids

Kod Code	Ø (cm) Ø (cm)	Koli/Adet Pcs/Ctn
30210300	30	2
30210360	36	2
30210400	40	2
30210450	45	2
30210500	50	2
30210550	55	2
30210600	60	2
30210650	65	1
30210700	70	1
30210800	80	1
30210900	90	1
30210100	100	1
30210110	110	1





» Kuskus Tencere Süzgeci
Couscous Colander

Kod Code	Øxh (cm) Øxh (cm)	Koli/Adet Pcs/Ctn
35664032	40x24	1
35665040	50x24	1
35666045	60x24	1

» Kuskus Tencere Seti (Kapaklı)
Couscous Set (w/lid)

Kod Code	Øxh (cm) Øxh (cm)	Lt Lt	Koli/Adet Pcs/Ctn
35614032	A 40x24 B 32x32	30	1
35615040	A 50x24 B 40x40	47	1
35616040	A 60x24 B 40x40	65	1
35616045	A 60x24 B 45x45	65	1
35616050	A 60x24 B 50x50	65	1



» Makarna Pişirme Süzgeci
Pasta Colander

Kod Code	Özellik Description	Koli/Adet Pcs/Ctn
36302420	24x19,5 Tencere ile uyumludur / Suitable for 24x19,5 Pot	3
36303623	36x22 Tencere ile uyumludur / Suitable for 36x22 Pot	4
36304026	40x25 Tencere ile uyumludur / Suitable for 40x25 Pot	4



» Makarna Pişirme Süzgeci Seti
Pasta Colander Set

Kod Code	Øxh (cm) Øxh (cm)	Lt Lt	Koli/Adet Pcs/Ctn
36312420	24x19,5 (3 Süzgeçli/ 3 Colanders)	8,0	1
36313623	36x22 (4 Süzgeçli/4 Colanders)	22,4	1
36314026	40x25 (4 Süzgeçli/4 Colanders)	32,0	1

* Fiyatlara kapak dahildir. / Lid is included in price



Paslanmaz Çelik Tavalar

- Paslanmaz çelik gövde
- Profesyonel kullanıma uygun ısıya dayanıklı paslanmaz çelik saplar
- Impact teknolojisi ile imal edilmiş 3 kat sandviç taban
- Her kullanıma uygun ölçü seçenekleri
- Mükemmel ısı dağılımı
- Saten yüzey
- İndüksiyon ocaklara uygundur

Stainless Steel Pans

- Stainless Steel 18/10 body
- Heat Resistant Stainless Steel Professional Handles
- Impact bonded sandwich bottom
- Multiple size options for various cooking
- Even Heat Distribution
- Satin Finishing





» Tek Saplı Tava
Fry pan

Kod Code	Øxh (cm) Øxh (cm)	Lt Lt	Koli/Adet Pcs/Ctn
30152004	20x5	1,6	4
30152405	24x5,5	2,5	4
30152806	28x6	3,7	4
30153206	32x7	6,0	1
30153606	36x7	8,1	1
30154007	40x8	10,1	1

* Ø32, Ø36, Ø40 Destek sap ilavedir
* Ø32, Ø36, Ø40 w/helper handle

» Tek Saplı Yapışmaz Çelik Tava
Non-Stick Coated Fry Pan

Kod Code	Øxh (cm) Øxh (cm)	Lt Lt	Koli/Adet Pcs/Ctn
30342004	20x5	1,6	4
30342405	24x5,5	2,5	4
30342805	28x6	3,7	4
30343207	32x7	6,0	1
30343608	36x7	8,1	1
30344008	40x8	10,1	1

* Ø32, Ø36, Ø40 Destek sap ilavedir
* Ø32, Ø36, Ø40 w/helper handle

* İndüksiyon ocaklarda kullanılmaz.
* Not suitable for induction



» Derin Tava (Balık Tava)
Saute Pan

Kod Code	Øxh (cm) Øxh (cm)	Lt Lt	Koli/Adet Pcs/Ctn
30452004	20x5	1,6	4
30452405	24x5,5	2,5	4
30452805	28x8	3,7	4
30453207	32x7,5	6,0	2
30453606	36x8	8,1	1

23



» Çift Saplı Tava (Paella)
Paella Pan

Kod Code	Øxh (cm) Øxh (cm)	Lt Lt	Koli/Adet Pcs/Ctn
30362004	20x5	1,6	4
30362405	24x5,5	2,5	4
30362806	28x6	3,7	2
30363207	32x6,5	6,0	2
30363608	36x7,5	8,1	2
30364008	40x8	10,1	2



» Sahanlar
French Omelette Pan

Kod Code	Øxh (cm) Øxh (cm)	Koli/Adet Pcs/Ctn
30315014	14x3	10
30315016	16x3	10
30315018	18x3	8
30315020	20x3	8
30315022	22x3	6
30315024	24x3	6
30315028	28x3	2
30315032	32x3	2



» Helvane Tava
Wide Shallow Pan w/o Lid

Kod Code	Øxh (cm) Øxh (cm)	Lt Lt	Koli/Adet Pcs/Ctn
30323008	30x8	5,0	3
30323609	36x9	9,0	3
30323812	38x12	13,5	3
30324012	40x12	15,7	2
30324512	45x12	19,0	2
30325012	50x12	23,0	2
30326014	60x14	34,0	1
30327015	70x14	53,5	1
30328016	80x16	73,0	1







» Derin Kaçarola
Deep Sauce Pan

Kod Code	Øxh (cm) Øxh (cm)	Lt Lt	Koli/Adet Pcs/Ctn
30150008	16x11	2,2	6
30150004	18x12	3,1	4
30150005	20x13	4,1	4
30150019	22x14	5,3	2
30150006	24x15	6,8	2
30150020	28x17	10,5	2
30150021	30x12	8,5	2
30150030	32x15	12,1	2

*Ø28, Ø30, Ø32 Destek sap ilavedir

*Ø28, Ø30, Ø32 w/helper Handle



» Sığ Kaçarola
Shallow Sauce Pan

Kod Code	Øxh (cm) Øxh (cm)	Lt Lt	Koli/Adet Pcs/Ctn
30150007	12x6	0,7	6
30150010	14x7	1,1	6
30150015	16x7	1,4	6
30150018	18x8	2,0	4
30150017	20x9	2,8	4
30150016	22x9,5	3,6	2
30150014	24x10,5	4,7	2



» Tabansız Kaçarola
Sauce Pan without Sandwich Bottom

Kod Code	Øxh (cm) Øxh (cm)	Lt Lt	Koli/Adet Pcs/Ctn
30381206	12x6	0,7	6
30381407	14x7	1,1	6
30381607	16x7	1,4	6
30381611	16x11	2,2	6
30381809	18x8	2,0	4
30381812	18x12	3,1	4
30382010	20x9	3,2	4
30382013	20x13	4,1	4
30382411	24x10,5	5,0	2
30382415	24x15	6,8	2
30382814	28x14	7,6	2

* Pişirme amaçlı kullanılmaz.

* Not suitable for cooking

25



» Yapışmaz Sote Tava
Non-stick Coated Conical Saute Pan

Kod Code	Øxh (cm) Øxh (cm)	Lt Lt	Koli/Adet Pcs/Ctn
30331605	16x6	0,75	4
30331805	18x6,5	1,0	4
30332005	20x7	1,9	2
30332405	24x8	2,5	2



» Sote Tava
Conical Saute Pan

Kod Code	Øxh (cm) Øxh (cm)	Lt Lt	Koli/Adet Pcs/Ctn
30431606	16x6	0,75	4
30431806	18x6,5	1,0	4
30432006	20x7	1,9	2
30432406	24x8	2,5	2

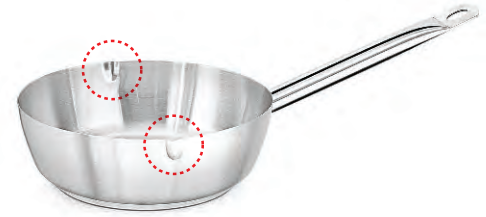

» Sote Tava (Çift Dökme Ağızlı)
Conical Saute Pan w/Double Spouts

Kod Code	Øxh (cm) Øxh (cm)	Lt Lt	Koli/Adet Pcs/Ctn
30351606	16x6	0,75	4
30351806	18x6,5	1,0	4
30352007	20x7	1,9	2
30352408	24x8	2,5	2



Alüminyum Yapışmaz Tavalar / Aluminum Non-Stick Pans

- Özel 3003 alaşım 3 mm kalınlığında alüminyum gövde
- Dupont Teflon Platinum Plus kaplama
- Profesyonel kullanıma uygun paslanmaz çelik saplar
- Doğa dostu: PFOA içermez
- İndüksiyon ocaklara uygundur

- Made from Special 3003 alloy aluminium
- Stay Cool Stainless Steel Pipe Handles with professional riveting fixing
- Made for Avid Chefs who demand Quality
- Eco Friendly: PFOA Free
- Suitable for induction



26

Alüminyum Tavalar (Platinum Teflon) Aluminum Non Stick Pans (Platinum Teflon)



» Yapışmaz Alüminyum Kızartma Tava Aluminum Non Stick Fry Pan

Kod Code	Ø (cm) Ø (cm)	Koli/Adet Pcs/Ctn
12021020	20	6
12021024	24	6
12021028	28	6
12021032	32	6
12021036	36	6
12021040	40	6



» Yapışmaz Alüminyum Krep Tava Aluminum Non Stick Crepe Pan

Kod Code	Ø (cm) Ø (cm)	Koli/Adet Pcs/Ctn
12123024	24	6
12123028	28	6



» Yapışmaz Alüminyum Wok Tava Aluminum Non Stick Wok Pan

Kod Code	Ø (cm) Ø (cm)	Koli/Adet Pcs/Ctn
12144024	24	6
12144028	28	6
12144030	30	6



- Bakteri oluşumunu önleyen üç kat emaye ile kaplıdır
- Buhar tutucu özel kapak tasarımı sayesinde vitamin ve mineral kaybını önler
- Isıyı hızla emer, uzun süre muhafaza eder
- Mükemmel iletkenliği ve eşit ısı dağılımı ile enerji tasarrufu sağlar
- Kesilme ve çizilmeye karşı dayanıklı yüzey metal ekipmanları kullanabilme rahatlığı sağlar
- Her tür ocak ve fırında kullanılabilme özelliği
- Yapışmaz, kolay temizlenebilir



- Triple enamel coating that ensures hygiene
- Vapor binding cover, prevents the loss of vitamins and minerals
- It absorbs heat rapidly and protects it for a long time
- Also good for food presentation at buffets
- Energy saving is provided by perfect thermal conductivity and balanced heat distribution
- Cut and scratch resistant surface provides the convenience of using metal equipments
- Suitable for all kinds of energy hobs and ovens
- Non - stick, easy to clean



» Mini Tencere / Mini Pot)

Kod Code	Model Model	Øxh (cm) Øxh (cm)	Lt Lt	Koli/Adet Pcs/Ctn
48011110	Tencere/ Pot	10	0,35	1
48013110	Altık/ Wooden Base			1
48014110	3'lü Altık /Wooden Base for 3 Pots			1



» Tencere / Pot)

Kod Code	Model Model	Øxh (cm) Øxh (cm)	Lt Lt	Koli/Adet Pcs/Ctn
48011120	Tencere/ Pot	20	2,56	1
48013120	Altık/ Wooden Base			1
48011124	Tencere/ Pot	24	4,93	1
48013124	Altık/ Wooden Base			1
48011128	Tencere/ Pot	28	6,80	1
48013128	Altık/ Wooden Base			1



27



» Yayvan Tencere / Shallow Pot)

Kod Code	Model Model	Øxh (cm) Øxh (cm)	Lt Lt	Koli/Adet Pcs/Ctn
48011424	Tencere/ Pot	24	2,40	1
48013424	Altık/ Wooden Base			1
48011428	Tencere/ Pot	28	3,40	1
48013428	Altık/ Wooden Base			1



Döküm Tavalalar /Cast Iron Pans



» Döküm Tepsi

Cast Iron Grill Tray Pan

Kod Code	Model Model	Ölçü (cm) Dims. (cm)	Koli/Adet Pcs/Ctn
48012230	Tava/Pan	22x30	1
48022230	Altılık/Wood Base		1
48012640	Tava/Pan	26x40	1
48022640	Altılık/Wood Base		1



» Döküm Yuvarlak Tava

Cast Iron Round Pan

Kod Code	Model Model	Ø (cm) Ø (cm)	Koli/Adet Pcs/Ctn
48010016	Tava/Pan	16	1
48020016	Altılık/Wood Base		1
48010020	Tava/Pan	20	1
48020020	Altılık/Wood Base		1
48021016	Seramik Sos Kabı Ceramic Sauce Cup		3

» Döküm Izgara Tava

Cast Iron Rectangular Grill Pan

Kod Code	Model Model	Ölçü (cm) Dims. (cm)	Koli/Adet Pcs/Ctn
48012647	Tava/Pan	26x47	1
48022647	Altılık/Wood Base		1

28



» Döküm Fajita Tavası

Cast Iron Fajita Pan

Kod Code	Model Model	Ölçü (cm) Dims. (cm)	Koli/Adet Pcs/Ctn
48011824	Tava/Pan	18,5x24,5	1
48021824	Altılık/Wood Base		1
48011529	Tava/Pan	15x29,5	1
48021529	Altılık/Wood Base		1

» Döküm Balık Tavası

Cast Iron Fish Pan

Kod Code	Model Model	Ölçü (cm) Dims. (cm)	Koli/Adet Pcs/Ctn
48011524	Tava/Pan	15x24,5	1
48021524	Altılık/Wood Base		1

» Döküm Sac Kavrurma Tavası

Cast Iron Sheet Roasting Pan

Kod Code	Model Model	Ø (cm) Ø (cm)	Koli/Adet Pcs/Ctn
48018020	Tava/Pan	20	1
48028020	Altılık/Wood Base		1
48018028	Tava/Pan	28	1
48028028	Altılık/Wood Base		1



» Döküm Pizza-Krep-Pankek Tava

Cast Iron Pizza-Creppe-Pancake Pan

Kod Code	Model Model	Ø (cm) Ø (cm)	Koli/Adet Pcs/Ctn
48011220	Tava/Pan	20	1
48021220	Altılık/Wood Base		1
48011227	Tava/Pan	28	1
48021228	Altılık/Wood Base		1



» Döküm Izgara Tava (Porsiyonluk)
Cast Iron Grill Pan (1 Portion)

Kod Code	Model Model	Ölçü (cm) Dims. (cm)	Koli/Adet Pcs/Ctn
48011616	Tava/Pan	16x16	1
48021616	Altılık/Wood Base		1



» Döküm Mini Izgara Tava
Cast Iron Mini Grill Pan

Kod Code	Model Model	Ölçü (cm) Dims. (cm)	Koli/Adet Pcs/Ctn
48011522	Tava/Pan	15x22	1
48021522	Altılık/Wood Base		1



» Döküm Kare Izgara Tava
Cast Iron Square Grill Pans

Kod Code	Model Model	Ölçü (cm) Dims. (cm)	Koli/Adet Pcs/Ctn
48012626	Tava/Pan	26x26	1
48022626	Altılık/Wood Base		1



» Döküm Yarı Düz Izgara Tava
Cast Iron Semi Grill/Semi Flat Pan

Kod Code	Model Model	Ölçü (cm) Dims. (cm)	Koli/Adet Pcs/Ctn
48002632	Tava/Pan	26x32	1
48022732	Altılık/Wood Base		1



» Döküm Izgara Yüzey Dörtgen Tava
Cast Iron Ribbed Skillet

Kod Code	Model Model	Ölçü (cm) Dims. (cm)	Koli/Adet Pcs/Ctn
48032632	Tava/Pan	26x32	1
48042632	Altılık/Wood Base		1



480

481

482



» Döküm Izgara Yüzey Tava
Cast Iron Ribbed Frying Pan

Kod Code	Model Model	Ø (cm) Ø (cm)	Koli/Adet Pcs/Ctn
48011228	Tava/Pan	28	1
48013228	Altılık/Wood Base		1



» Döküm Düz Yüzey Tava
Cast Iron Frying Pan

Kod Code	Model Model	Ø (cm) Ø (cm)	Koli/Adet Pcs/Ctn
48011328	Tava/Pan	28	1
48013328	Altılık/Wood Base		1



» Döküm Sahan
Cast Iron French Omelette Pan

Kod Code	Model Model	Ø (cm) Ø (cm)	Koli/Adet Pcs/Ctn
48111322	Tava/Pan	22	1
48013322	Altılık/Wood Base		1



480

481

482



480

481

482



481

Roasteasy

- İçi daha yumuşak dışı daha çıtır et, tavuk, balık ve sebzeleriniz için ideal pişirme
- Patentli formül sayesinde nemi koruyarak küçülmeden, kurumadan yeterli miktarda havayla temas ederek mükemmel kızarma ve çıtırılık sağlar
- Zincirin delikleri sayesinde pişirme esnasında yemeği rahatça soslayabilme
- Yemeği fırından çıkarttıktan sonra dinlendirme esnasında da sıcak tutar
- Pişirme esnasında çelik ısıyı eşit iletir bu sayede hiç bir bölge çiğ kalmaz
- Elde ve bulaşık makinesinde yıkanabilir
- Gıdayla temasa uygun yüksek kalite çelikten üretilmiştir (NF A36-711)
- Çevre dostu

- Measuring 40x40 cm Roasteasy covers the largest chicken or smaller size roast joint
- Great alternative to tinfoil
- Allows venting and not sweating
- Allows perfect browning and crisping
- Reduces burning
- Roasteasy can be used during or after cooking
- Ideal for use in convection ovens
- Ideal for cooking meats, chicken or fish
- Can be used for barbecuing steaks & prawns also be used as an ideal diffuser on the barbecue
- Reduces shrinkage
- Retains natural juices and enhances flavours
- Maintains texture and shape for perfect carving
- Roasteasy is a reusable whole of lifetime product
- Stays warm allowing your roast to rest & relax without losing its heat
- Roasteasy is dishwasher proof, easy-clean and reduces fat spit and spray in oven interiors



» Paslanmaz Çelik Pişirme Örtüsü
Stainless Steel Roasteasy

Kod Code	Ölçü Dimensions	Koli/Adet Pcs/Ctn
65620001	40x40	1



Fırın Tepsileri / Roasting Pans



» Kapaklı
Roasting Pan w/Clip-on Cover

Kod Code	Ölçü Dims. (cm)	Koli/Adet Pcs/Ctn
30714565	40x60x5	2
30714568	40x60x8	2
30714561	40x60x10	2
30715355	50x35x5	2
30715358	50x35x8	2
30715310	50x35x10	2
30715705	50x70x5	2
30715708	50x70x8	2
30715710	50x70x10	2



» Kapaksız
Tapered Roasting Pan

Kod Code	Ölçü Dims. (cm)	Koli/Adet Pcs/Ctn
30704565	40x60x5	2
30704568	40x60x8	2
30704561	40x60x10	2
30705355	50x35x5	2
30705358	50x35x8	2
30705310	50x35x10	2
30705705	50x70x5	3
30705708	50x70x8	3
30705710	50x70x10	3



» Kapak
Cover

Kod Code	Ölçü Dims. (cm)	Koli/Adet Pcs/Ctn
30705711	40x60	1
30705713	50x35	1
30705712	50x70	1



» Emaye Kaplı 1/1 Fırın Tepsisi
Enamel Coated 1/1 Roasting Pan

Kod Code	Ölçü(mm) Dims. (mm)	Lt Lt	Koli/Adet Pcs/Ctn
31811020	1/1-20	2,5	5
31811040	1/1-40	5	5
31811065	1/1-65	9	10



» Yapışmaz Kaplı GN Fırın Tepsisi (S/S)
Nonstick GN Roasting Pan (S/S)

Kod Code	Ölçü(mm) Dims. (mm)	Lt Lt	Koli/Adet Pcs/Ctn
31311020	1/1-20	2,5	5
31321020	2/1-20	5	5



» Yapışmaz GN Fırın Tepsisi (Alüminyum)
Nonstick GN Roasting Pan (Aluminum)

Kod Code	Ölçü(mm) Dims. (mm)	Lt Lt	Koli/Adet Pcs/Ctn
31311030	1/1-20	2,5	5
33121030	2/1-20	5	5

31



» Yuvarlak
Round Roasting Pan (S / S)

Kod Code	Øxh (cm) Øxh (cm)	Koli/Adet Pcs/Ctn
30703805	36x5	4
30704505	45x5	4
30705005	50x5	2
30706005	60x5	2



» Alüminyum Pizza Tepsisi
Aluminium Pizza Tray

Kod Code	Ø (cm) Ø (cm)	Koli/Adet Pcs/Ctn
43010018	18	4
43010020	20	4
43010022	22	4
43010024	24	4
43010026	26	2
43010028	28	2
43010030	30	2
43010032	32	2
43010040	40	2







Hazırlık/Preparing



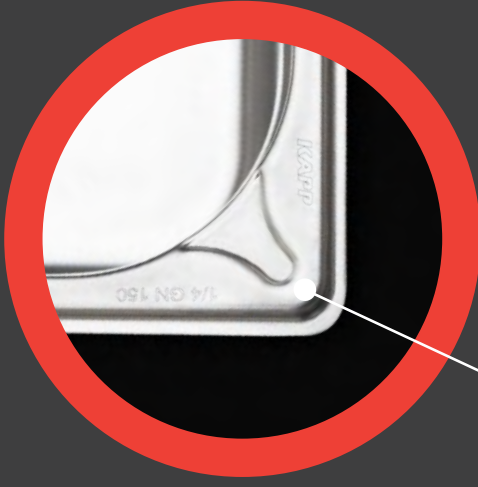

- * Kıvrılmayı önleyen ekstra güçlendirilmiş köşeler
- * *Extra endurance that prevents bending on the edges*

Gastronorm Küvet Özellikleri

- ° Kuvvetlendirilmiş köşeler
- ° 2/1 - 1/9 aralığında geniş ölçü seçeneği
- ° 20-200 mm aralığında derinlik seçeneği
- ° Standart GN, saplı GN, ve delikli GN çeşitleri
- ° Standart, kepe delikli ve sızdırmaz contalı kapak çeşitleri
- ° İstiflenebilir
- ° Hazırlık, dondurma, depolama, yeniden ısıtma, ve servis için uygun

GN Food Pan Specs

- ° Reinforced Edges
- ° Sizes from 2/1 to 1/9
- ° 20-200 mm Depth
- ° Standard, Handled and Perforated Types
- ° Standard, Notched and Sealed Lid Types
- ° Stackable
- ° Suitable for Preparing, Freezing, Storage, Reheating and Serving

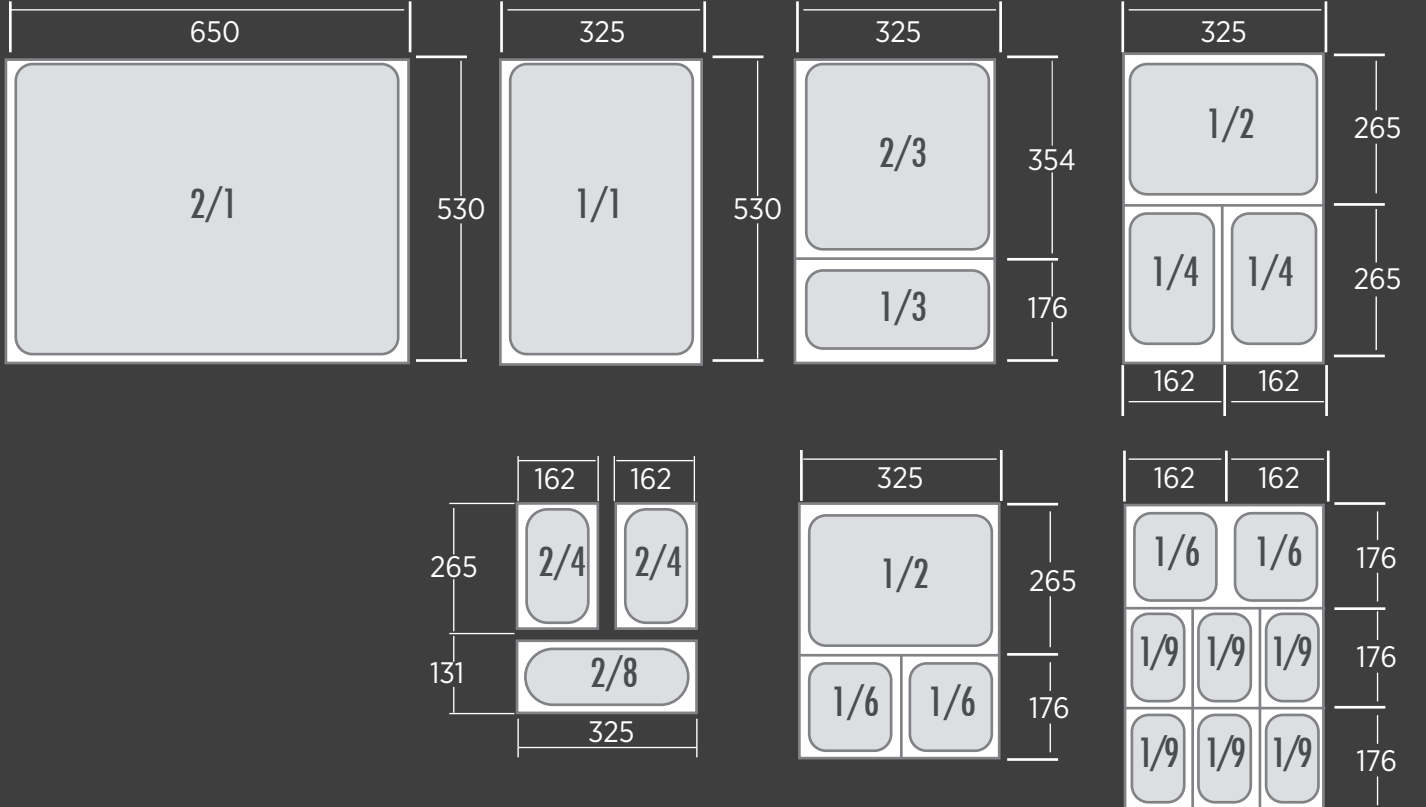





* Tüm ölçüler mm cinsindedir.

* All sizes mm.

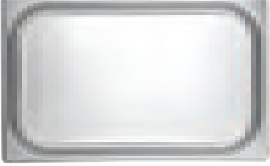

Standart Gastronorm Kvetler
GN Food Pans

		Kod Code	Derinlik (mm) Depth (mm)	Lt Lt	Koli/Adet Pcs/Ctn
	2/1 650x530	31021010	10	2,5	10
		31021020	20	5,0	10
		31021040	40	10,0	10
		31021065	65	18,5	10
		31021100	100	28,5	5
		31021150	150	42,5	5
		31021200	200	57,5	3
	1/1 530x325	31011010	10	1,25	20
		31011020	20	2,5	20
		31011040	40	5,0	20
		31011065	65	9,0	11
		31011100	100	14,0	10
		31011150	150	21,0	10
		31011200	200	28,0	8
	2/3 354x325	31023020	20	1,5	20
		31023040	40	3,0	20
		31023065	65	5,5	20
		31023100	100	9,0	20
		31023150	150	13,0	15
		31023200	200	18,0	10
	1/2 325x265	31012020	20	1,25	25
		31012040	40	2,0	30
		31012065	65	4,0	30
		31012100	100	6,5	25
		31012150	150	9,5	13
		31012200	200	12,5	10
	1/3 325x176	31013020	20	0,75	60
		31013040	40	1,5	40
		31013065	65	2,5	40
		31013100	100	4,0	30
		31013150	150	5,7	30
		31013200	200	7,8	20



Standart Gastronorm Kvetler GN Food Pans		Kod Code	Derinlik (mm) Depth (mm)	Lt Lt	Koli/Adet Pcs/Ctn
	1/4 265x162	31014020	20	0,5	30
		31014040	40	1,0	30
		31014065	65	1,8	30
		31014100	100	2,8	30
		31014150	150	4,0	30
		31014200	200	5,5	20
	2/4 530x162	31024020	20	0,5	20
		31024040	40	1,3	18
		31024065	65	2,3	16
		31024100	100	5,2	14
	2/8 325x132	31028065	65	1,0	10
		31028100	100	2,0	10
	1/6 176x162	31016065	65	1,0	40
		31016100	100	1,6	40
		31016150	150	2,4	30
		31016200	200	3,4	20
	1/9 176x108	31019065	65	0,6	80
		31019100	100	1,0	70

Süzgeçli Gastronorm Küvetler / Perforated GN Food Pans

Süzgeçli Gastronorm Küvetler
Perforated GN Food Pans





		Kod Code	Derinlik (mm) Depth (mm)	Koli/Adet Pcs/Ctn
	2/1 650x530	30921020	20	10
		30921040	40	10
		30921065	65	10
		30921100	100	5
		30921150	150	5
		30921200	200	3
	1/1 530x325	30911020	20	20
		30911040	40	20
		30911065	65	11
		30911100	100	10
		30911150	150	10
		30911200	200	8
	2/3 354x325	30923020	20	20
		30923040	40	20
		30923065	65	20
		30923100	100	20
		30923150	150	15
		30923200	200	10
	1/2 325x265	30912020	20	25
		30912040	40	30
		30912065	65	30
		30912100	100	25
		30912150	150	13
		30912200	200	10

Süzgeçli Gastronorm Küvetler / Perforated GN Food Pans

Süzgeçli Gastronorm Küvetler
Perforated GN Food Pans



		Kod Code	Derinlik (mm) Depth (mm)	Koli/Adet Pcs/Ctn
	1/3 325x176	30913020	20	60
		30913040	40	40
		30913065	65	40
		30913100	100	30
		30913150	150	30
		30913200	200	20
	1/4 265x162	30914020	20	30
		30914040	40	30
		30914065	65	30
		30914100	100	30
		30914150	150	30
		30914200	200	20
	1/6 176x132	30916065	65	40
		30916100	100	40
		30916150	150	30
		30916200	200	20



Saplı Gastronorm Kvetler / GN Food Pans w/Handle



Saplı Gastronorm Kvetler
GN Food Pans w/Handle



40

		Kod Code	Derinlik (mm) Depth (mm)	Lt Lt	Koli/Adet Pcs/Ctn
	2/1 650x530	31121065	65	18,5	10
		31121100	100	28,5	5
		31121150	150	42,5	5
		31121200	200	57,5	3
	1/1 530x325	31111065	65	9,0	11
		31111100	100	14,0	10
		31111150	150	21,0	10
		31111200	200	28,0	8
	2/3 354x325	31123065	65	5,5	20
		31123100	100	9,0	20
		31123150	150	13,0	15
		31123200	200	18,0	10
	1/2 325x265	31112065	65	4,0	30
		31112100	100	6,5	25
		31112150	150	9,5	13
		31112200	200	12,5	10

Saplı Gastronorm Kvetler / GN Food Pans w/Handle

Saplı Gastronorm Kvetler
GN Food Pans w/Handle

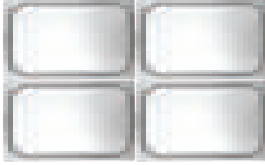

		Kod Code	Derinlik (mm) Depth (mm)	Lt Lt	Koli/Adet Pcs/Ctn
	1/3 325x176	31113065	65	2,5	40
		31113100	100	4,0	30
		31113150	150	5,7	30
		31113200	200	7,8	20
	1/4 265x162	31114065	65	1,8	30
		31114100	100	2,8	30
		31114150	150	4,0	30
		31114200	200	5,5	20
	1/6 176x162	31116065	65	1,0	40
		31116100	100	1,6	40
		31116150	150	2,4	30
		31116200	200	3,4	20

41





» Standart

Standart

Kod Code	Model Model	Ölçü (mm) Dim (mm)	Koli/Adet Pcs/Ctn
31921530	2/1	650x530	15
31911325	1/1	530x325	15
31923325	2/3	354x325	20
31924300	2/4	530x162	12
31928300	2/8	325x132	12
31912265	1/2	325x265	30
31913176	1/3	325x176	30
31914162	1/4	265x162	30
31916162	1/6	176x162	30
31919108	1/9	176x108	30

» Sap Delikli

Lid w/Handle Hole

Kod Code	Model Model	Ölçü (mm) Dim (mm)	Koli/Adet Pcs/Ctn
32100021	2/1	650x530	6
32100011	1/1	530x325	6
32100023	2/3	354x325	6
32100012	1/2	325x265	6
32100013	1/3	325x176	6
32100014	1/4	265x162	6
32100016	1/6	176x162	12



» Kepçe Delikli

Lid w/Ladle Hole

Kod Code	Model Model	Ölçü (mm) Dim (mm)	Koli/Adet Pcs/Ctn
32100121	2/1	650x530	6
32100111	1/1	530x325	6
32100123	2/3	354x325	6
32100112	1/2	325x265	6
32100113	1/3	325x176	6
32100114	1/4	265x162	6
32100116	1/6	176x162	12

» Sızdırmaz Contalı

Lid w/Hermatic Seal

Kod Code	Model Model	Ölçü (mm) Dim (mm)	Koli/Adet Pcs/Ctn
31923311	1/1	530x325	15
31923312	1/2	325x265	15
31923313	1/3	325x176	15
31923314	1/4	265x162	20

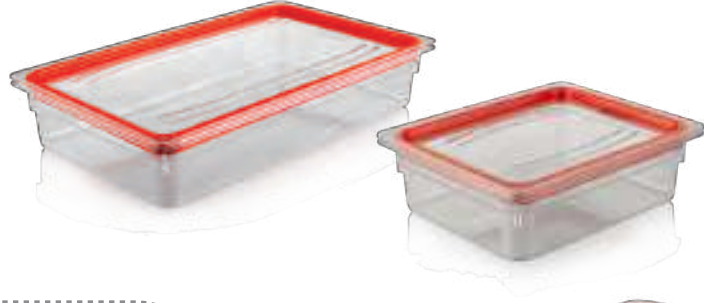

plast|port®
by KAPP

» PC Sızdırmaz Contalı (PC GN Küvet uyumlu)

PC Lid w/Hermetic Seal for PC GN Containers

Kod Code	Model Model	Ölçü (mm) Dim (mm)	Koli/Adet Pcs/Ctn
46011011	1/1	530x325	6
46011012	1/2	325x265	6

* GN Küvet fiyata dahil değildir.

* GN pan is not included in price

43

also available

BPA
FREE



plast|port®
by KAPP

» PC Sızdırmaz Contalı (Paslanmaz GN Küvet uyumlu)

PC Lid w/Hermetic Seal for S/S GN Containers

Kod Code	Model Model	Ölçü (mm) Dim (mm)	Koli/Adet Pcs/Ctn
46012011	1/1	530x325	6

* GN Küvet fiyata dahil değildir.

* GN pan is not included in price

plast|port®
by KAPP

» Polikarbonat GN Kapak

PC GN Lid

Kod Code	Model Model	Ölçü (mm) Dim (mm)	Koli/Adet Pcs/Ctn
46010011	1/1	530x325	12
46010012	1/2	325x265	12
46010013	1/3	325x176	12
46010014	1/4	265x162	12
46010016	1/6	176x162	24
46010019	1/9	176x108	24

* Paslanmaz Çelik GN Küvetler ile uyumludur.

* Suitable for S/S GN pans.

Bain Marie Kvetler / Bain Marie Containers



» A

A

Kod Code	Model Model	l (mm) Dim (mm)	h (mm) h (mm)	Lt Lt	Koli/Adet Pcs/Ctn
31622235	A1	240x240	235	13	4
31622160	A2	240x240	160	9	4
31622075	A3	240x240	75	4	4
31622300	A (Kapak / Lid)	240x240			4



44

» B

B

Kod Code	Model Model	l (mm) Dim (mm)	h (mm) h (mm)	Lt Lt	Koli/Adet Pcs/Ctn
31611235	B1	155x155	235	5	4
31611160	B2	155x155	160	3,5	4
31611075	B3	155x155	75	1,5	4
31611300	B (Kapak / Lid)	155x105			4



» C

C

Kod Code	Model Model	l (mm) Dim (mm)	h (mm) h (mm)	Lt Lt	Koli/Adet Pcs/Ctn
31610160	C2	155x155	160	2,5	4
31610075	C3	155x155	75	1	4
31610055	C4	155x155	55	0,5	4
31610300	C (Kapak / Lid)	155x105			4



» Dondurma Küveti

GN Ice Cream Pan

Kod Code	Lt Lt	Ölçü (cm) Dim (cm)	Koli/Adet Pcs/Ctn
31236065	4	36x17x6,5	15
31236100	6,1	36x17x10	15
31236120	7,3	36x17x12	15
31236150	9,2	36x17x15	15



» PP Dondurma Küveti

PP GN Ice Cream Pan

Kod Code	Lt Lt	Ölçü (cm) Dim (cm)	Koli/Adet Pcs/Ctn
46010002	4,5	36x17x11	12



» PC Dondurma Küveti

PC GN Ice Cream Pan

Kod Code	Lt Lt	Ölçü (cm) Dim (cm)	Koli/Adet Pcs/Ctn
46010001	4,5	36x17x11	12



» Emaye Kaplı 1/1 Fırın Tepsisi
Enamel Coated 1/1 Roasting Pan

Kod Code	Ölçü(mm) Dims. (mm)	Lt Lt	Koli/Adet Pcs/Ctn
31811020	1/1-20	2,5	5
31811040	1/1-40	5	5
31811065	1/1-65	9	10



» Yapışmaz Kaplı GN Fırın Tepsisi (S/S)
Nonstick GN Roasting Pan (S/S)

Kod Code	Ölçü(mm) Dims. (mm)	Lt Lt	Koli/Adet Pcs/Ctn
31311020	1/1-20	2,5	5
31321020	2/1-20	5	5



» Yapışmaz GN Fırın Tepsisi (Alüminyum)
Nonstick GN Roasting Pan (Aluminum)

Kod Code	Ölçü(mm) Dims. (mm)	Lt Lt	Koli/Adet Pcs/Ctn
31311030	1/1-20	2,5	5
33121030	2/1-20	5	5

45

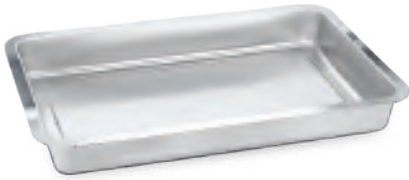

» Meze Küveti
Appetizer Pan

Kod Code	Ölçü (mm) Dim (mm)	Koli/Adet Pcs/Ctn
35011929	195x295x35	1
35012333	230x330x42	1
35012538	257x380x47	1
35012843	285x430x51	1



» PP Pizza Hamur Teknesi
PP Dough Tray

Kod Code	Lt Lt	Ölçü (cm) Dim (cm)	Koli/Adet Pcs/Ctn
46010026	16,8	40x60x7,7	8





» GN 1/1 Porselen

GN 1/1 Porcelain Food Pan

Kod Code	Ölçü (mm) Dim (mm)	Koli/Adet Pcs/Ctn
70020101	530x325	1



» GN 1/2 Porselen

GN 1/2 Porcelain Food Pan

Kod Code	Ölçü (mm) Dim (mm)	Koli/Adet Pcs/Ctn
70020102	325x265	1



» GN 2/3 Porselen

GN 2/3 Porcelain Food Pan

Kod Code	Ölçü (mm) Dim (mm)	Koli/Adet Pcs/Ctn
70020203	354x325	1

46



» GN 1/3 Porselen

GN 1/3 Porcelain Food Pan

Kod Code	Ölçü (mm) Dim (mm)	Koli/Adet Pcs/Ctn
70020103	325x176	1



» Yuvarlak Porselen

Round Porcelain Food Pan

Kod Code	Ölçü (cm) Dim (cm)	Koli/Adet Pcs/Ctn
70020100	39x6,5	1



» Yuvarlak Bölmeli Porselen

Round Divided Porcelain Food Pan

Kod Code	Ölçü (cm) Dim (cm)	Koli/Adet Pcs/Ctn
70021100	39x6,5	1



» Yuvarlak Bölmeli Tepsi

Round Divided Food Pan (S/S)

Kod Code	Ölçü (cm) Dim (cm)	Koli/Adet Pcs/Ctn
70023100	38,5x38,5x6,5	1



» Yuvarlak Tepsi

Round Food Pan (S/S)

Kod Code	Ölçü (cm) Dim (cm)	Koli/Adet Pcs/Ctn
30703565	35x6,5	4





» Süzgeç Taban
Drainer Plate

Kod Code	Ölçü (mm) Dim (mm)	Model Model	Koli/Adet Pcs/Ctn
80026565	465x265	1/1	4
80026523	285x265	2/3	4
80026520	265x220	1/2	4
80026515	265x115	1/3	4



» Tel Izgara
Wire Grid

Kod Code	Ölçü (mm) Dim (mm)	Model Model	Koli/Adet Pcs/Ctn
80022530	530x325	GN 1/1 (304-18/10)	12
80026530	650x530	GN 2/1 (304-18/10)	12
80025425	600x400	Tel Izgara/Wire Grid (304-18/10)	12
50701530	530x325	GN 1/1 (201-18/02)	12
50701650	650x530	GN 2/1 (201-18/02)	12
50701600	600x400	Tel Izgara/Wire Grid (201-18/02)	12



» Gastronom Süzgeç
Colander for GN Pan

Kod Code	Koli/Adet Pcs/Ctn
30900000	1

* GN Küvet fiyata dahil değildir.
* GN Pan not included in price.



» GN 1/1 Yükseltici
GN 1/1 Angled Adaptor Plate

Kod Code	Ölçü (mm) Dim (mm)	Koli/Adet Pcs/Ctn
54010002	530x325	2

* GN Küvet fiyata dahil değildir.
* GN Pan not included in price.



» Sıcak Kap / GN Tutucu S/S
S/S Grid for Hot Dishes

Kod Code	Koli/Adet Pcs/Ctn
62010041	6

* GN Küvet fiyata dahil değildir.
* GN Pan not included in price.



» GN Destek Aparatı
GN Adjustment Bar

Kod Code	Ölçü (mm) Dim (mm)	Model Model	Koli/Adet Pcs/Ctn
50020032	325	GN 1/1	4
80020053	530	GN 2/1	4

plast | port[®]
by **KAPP**





Polikarbonat Gastronorm Kvetler

Polycarbonate GN Pans







- Yksek darbe dayanımına sahiptir kırılmaz
- Yksek darbe dayanımından dolayı kşe ve kenar deformasyonu yařanmaz
- Asit dayanımı yksektir, delinmez
- +100°C / - 40°C ısıya dayanıklıdır
- Mikrodalga fırın kullanımına uygundur
- İ ie istiflenebilir, yer tasarrufu saęlar
- Hafiftir, kolay tařınabilir
- İnsan saęlıęına zararlı hammadde iermez
- Őeffaf yapısı sayesinde kullanım kolaylıęı saęlar

- High impact resistance, unbreakable
- No corner and border deformation due to high impact resistance
- High acid-proof, impenetrable
- Heat endurance beetween +100°C /-40°C
- Suitable for microwave oven
- Stackable one within the other
- Light , easy to carry
- No hazardous substances on human health
- Easy to use due to the transparent structure

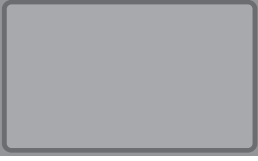

Polikarbonat Şeffaf
Gastronorm Kvetler
Polycarbonate GN Pans

50

		Kod Code	Derinlik (mm) Depth (mm)	Koli/Adet Pcs/Ctn
	1/1 530x325	46011065	65	6
		46011100	100	6
		46011150	150	6
		46011200	200	6
	Kapak/ Lid	46010011		12
	1/2 325x265	46012065	65	12
		46012100	100	12
		46012150	150	12
		46012200	200	12
	Kapak/ Lid	46010012		12
	1/3 325x176	46013065	65	12
		46013100	100	12
		46013150	150	12
		Kapak/ Lid	46010013	
		1/4 265x162	46014065	65
46014100			100	12
46014150			150	12
Kapak/ Lid			46010014	
		1/6 176x162	46016065	65
	46016100		100	12
	46016150		150	12
	Kapak/ Lid		46010016	
		1/9 176x108	46019065	65
46019100			100	12
46019150			150	12
Kapak/ Lid			46010019	

also available

BPA
FREE



Polikarbonat Siyah
Gastronorm K vetler
Polycarbonate Black
GN Pans

		Kod Code	Derinlik (mm) Depth (mm)	Koli/Adet Pcs/Ctn
	1/1 530x325	46111065	65	6
		46111100	100	6
		46111150	150	6
		46111200	200	6
	Kapak/ Lid	46010011		12
	1/2 325x265	46112065	65	12
		46112100	100	12
		46112150	150	12
		46112200	200	12
	Kapak/ Lid	46010012		12
	1/3 325x176	46113065	65	12
		46113100	100	12
		46113150	150	12
		Kapak/ Lid	46010013	
		1/4 265x162	46114065	65
46114100			100	12
46114150			150	12
Kapak/ Lid			46010014	
		1/6 176x162	46116065	65
	46116100		100	12
	46116150		150	12
	Kapak/ Lid		46010016	
		1/9 176x108	46119065	65
46119100			100	12
46119150			150	12
Kapak/ Lid			46010019	

Polikarbonat Ölçülü Kare Saklama Kapları

PC Square Food Storage Container w/Graduations

- Saklama, hazırlık, servis ve taşıma için idealdir
- Kırılmaz polikarbonattan imal edilmiştir
- Kırılmaz, çatlamaz, bükülmez ve çökme yapmaz
- 40° C' den 99° C' ye kadar dirençlidir
- Lt ve Qt ölçeği envanter düzeni için kullanışlıdır
- Kolay temizlenebilir

- Ideal for storing, preparing, serving display and transportation
- Made in unbreakable polycarbonate
- Nonbreakable, nonbending, can not be cracked or bent
- Withstand temperatures from 40° C to 99° C
- Standard and metric graduation markings, to easy inventory management
- Easy cleaning





» 18 Litre

18 Lt.

Kod Code	Ölçü (cm) Dim (cm)	Koli/Adet Pcs/Ctn
62030018	28,5x28,5x32	6



» 12 Litre

12 Lt.

Kod Code	Ölçü (cm) Dim (cm)	Koli/Adet Pcs/Ctn
62030012	28,5x28,5x21	6



» 8 Litre

8 Lt.

Kod Code	Ölçü (cm) Dim (cm)	Koli/Adet Pcs/Ctn
62030008	22,5x22,5x23	6



53



» 6 Litre

6 Lt.

Kod Code	Ölçü (cm) Dim (cm)	Koli/Adet Pcs/Ctn
62030006	22,5x22,5x19	6



» 3,8 Litre

3,8 Lt.

Kod Code	Ölçü (cm) Dim (cm)	Koli/Adet Pcs/Ctn
62030004	18,2x18,2x19	6



» 2 Litre

2 Lt.

Kod Code	Ölçü (cm) Dim (cm)	Koli/Adet Pcs/Ctn
62030002	18x18x10	6

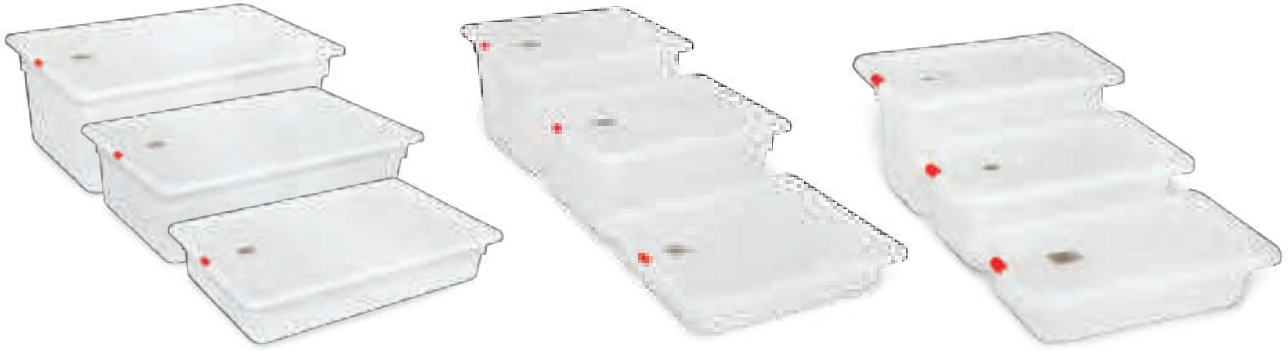

» 1/1

1/1

Kod Code	Ölçü (mm) Dim (mm)	Koli/Adet Pcs/Ctn
46021065	1/1-65	6
46021100	1/1-100	6
46021150	1/1-150	6
46021200	1/1-200	6
46020011	Kapak/Lid	6

» 1/2

1/2

Kod Code	Ölçü (mm) Dim (mm)	Koli/Adet Pcs/Ctn
46022065	1/2-65	12
46022100	1/2-100	12
46022150	1/2-150	12
46022200	1/2-200	12
46020012	Kapak/Lid	12

» 1/3

1/3

Kod Code	Ölçü (mm) Dim (mm)	Koli/Adet Pcs/Ctn
46023065	1/3-65	12
46023100	1/3-100	12
46023150	1/3-150	12
46020013	Kapak/Lid	12

54



» 1/4

1/4

Kod Code	Ölçü (mm) Dim (mm)	Koli/Adet Pcs/Ctn
46024065	1/4-65	12
46024100	1/4-100	12
46024150	1/4-150	12
46021014	Kapak/Lid	12

» 1/6

1/6

Kod Code	Ölçü (mm) Dim (mm)	Koli/Adet Pcs/Ctn
46021665	1/6-65	12
46026100	1/6-100	12
46026150	1/6-150	12
46020016	Kapak/Lid	12

» 1/9

1/9

Kod Code	Ölçü (mm) Dim (mm)	Koli/Adet Pcs/Ctn
46029065	1/9-65	12
46029100	1/9-100	12
46029150	1/9-150	12
46020019	Kapak/Lid	12

- Çift amaçlı iç hazne; yüksek kapasiteli süzgeç / sebze kurutucu
- Kaymaz çevirme kolu
- Ayrılabilir kapak ile kolay temizleme
- Kullanım esnasında stabil gövde sağlayan tasarım
- Transparan kapak
- Dual purposed inner basket; high capacity colander / salad spinner
- Non-slip knob
- Take the lid apart to make it easy to clean
- Designed to remain stable during use
- Transparent lid

» Sebze Kurutucu
Salad Spinner

Kod Code	Kapasite Capacity	Koli/Adet Pcs/Ctn
46700020	20 Lt	1



55





Made in France



» Sebze Tornası (Le Rouet Gourmet)

Turning Slicer Le Rouet Gourmet w/3 Knives

Kod Code	Ölçü (cm) Dim. (cm)	Koli/Adet Pcs/Ctn
62050011	36x13,5x24,3	1



Made in France



» Japon Tornası 3 Bıçaklı (Plastik)

Turning Slicer Plastic

Kod Code	Ölçü (cm) Dim. (cm)	Koli/Adet Pcs/Ctn
62050010	32,5x15,3x22	1

- 4 değişik kesim çeşidi (Dilimleme, Jülyen, Rende ve Zest)
- 1-10 mm arası ultra ince kesim kalınlığı
- Paslanmaz çelik sağlam ve profesyonel gövde
- V-şeklinde entegre bıçak
- Paslanmaz çelik yüksek kalite bıçaklar
- Plastik tutma aparatıyla güvenli kullanım
- Kaymaz kauçuk ayaklar



de BUYER
DEPUIS 1830

» Mandalin Kesme Ünitesi
Mandoline

Kod Code	Koli/Adet Pcs/Ctn
63010025	1



Made in France

- Multi-cuts : smooth slices, Juliennes, grate and zest
- Ultra-thin slices from 1 to 10 mm
- Robust and professional : in stainless steel
- V-shaped blade integrated
- Blades in pro. quality stainless steel
- Easy to use
- Complete safety thanks to the pusher, storage box and receptable for vegetables
- Compact storage



Dilim
Slice

Çubuk
Sticks

Jülyen
Jullienne

Küp
Dices

- 2, 3, 4 mm bıçaklar
- Jülyen kesim, dilimleme, çubuk kesim ve angel hair kesim
- Kağıt inceliğinde kesebilme özelliği
- Ayarlanabilir kesim kalınlığı

- Exceptional cutting: Paper-thin and crispy slices of fruits and vegetables
- Adjustable cutting thickness
- Removable blade for easy cleaning
- Come w/3 interchangeable "comb" blades (2-3-4 mm) and a handle guard

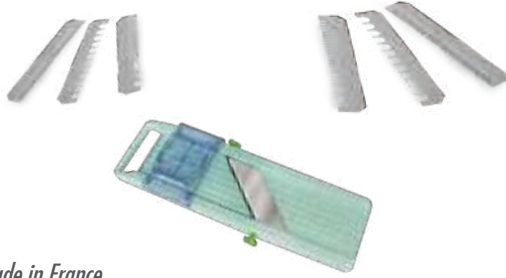

Made in France



Dilim Slice Çubuk Sticks Jülyen Julienne Angel Hair Angel Hair

» Mandalin 3 Bıçaklı
Japanese Mandoline

Kod Code	Koli/Adet Pcs/Ctn
62050009	1



» Ananas Soyma
Pineapple Peeler

Kod Code	Koli/Adet Pcs/Ctn
41030005	1

57

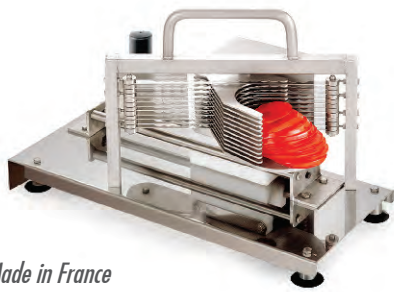

Made in France

» Domates Dilimleyici
Tomato Slicer

Kod Code	Koli/Adet Pcs/Ctn
62050007	1

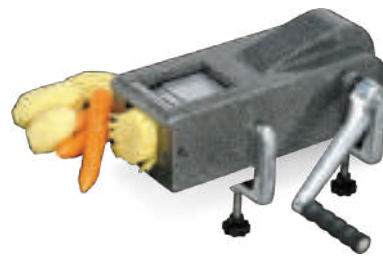

» Patates Dilimleme
French Fry Cutter

Kod Code	Ölçü (mm) Dim. (mm)	Koli/Adet Pcs/Ctn
41030003	9x9	1

Ergonomik / Ergonomic

Güvenli ve kolay kullanım için tasarlanmış geniş tutma kolu
Large handles for ease and safety of use

Çok Amaçlı / Multi-Purpose

Herhangi bir alet gerektirmeden kolayca değiştirilebilir itici başlık
Easily interchangeable pusher, no tools required

Rahat Kullanım / Comfortable

İticiyi otomatik geri iten yaylar kolay kullanım sağlar
Pusher return springs for easy use

Verimli / Efficient

Değiştirilebilir bıçak bloğu kolay ve temiz kesim sağlayan sertleştirilmiş çelikten üretilmiştir. Tek hamlede kusursuz kesilmiş ürünler elde edebilirsiniz.
Tempered steel blades for clean, easy cutting. Cutting results guarantee impeccable product presentation and optimal conservation. Interchangeable blade block

Uzun Ömürlü / Hardwearing

Dayanıklı kompozit gövde
Robust composite body

Pratik / Practical

Kesilen ürünler direk cihazın altına yerleştirilen kütetlere toplanır (GN 1/2 max. 100 mm derinlikteki kütet ile kullanılabilir)
Segments collection in a container to be placed directly under the appliance (GN 1/2 container max 100mm deep, not supplied)

Güvenli / Safe

Vakumlu ayaklar yüksek stabilite sağlar
Suction feet, high stability

58



Dilimleyici
Slicer



6 Dilim
8 Dilim /
6 Pieces
8 Pieces

Dilimleyici
Slicer



5 mm /
5 mm

Dilimleyici
Semi-Circle Slicer



2 Dilim / 2 Slices
5 mm / 5 mm

Patates Dilimleyici
French Fries Cutter



8x8 mm / 8x8 mm
10x10 mm / 10x10 mm

Patates Dilimleyici
French Fries Cutter



8x16 mm /
8x16 mm

Doğrayıcı (Göbek Çıkarıcı)
Corer Segmenter



8 Dilim
8 Pieces

- Meyve ve sebzeleri kolay, hızlı ve eşit bir şekilde doğrar
- Maksimum meyve-sebze çapı Ø 80 mm
- *For fast, regular and calibrated wedging of tomatoes, lemons, oranges and potatoes*
- *Maximum diameter of fruit Ø 80 mm*

- Dilimlenmek istenen her meyve sebzeyi kusursuz ve hızlı biçimde dilimler
- Maksimum meyve-sebze çapı Ø 80 mm
- *For tomatoes, citrus fruit, kiwis, 5 mm slices*
- *Maximum diameter of fruit Ø 80 mm*

- Özellikle domates dilimlerini sandviçlerde kullanmak için ikiye bölmek üzere tasarlanmıştır
- Aynı anda hem dilimler hem ikiye böler
- *Specially designed to slice tomatoes for use in sandwiches*
- *With large tomatoes, half-slicer are often better suited and easier to use in sandwiches*



» Sebze Meyve Doğrayıcı

Vegetable/Fruit Wedger

Kod Code	Model Model	Koli/Adet Pcs/Ctn
77505610	Gövde/Body	1
77505616	6 Dilim/6 Pieces	1
77505618	8 Dilim/8 Pieces	1

» Sebze Meyve Dilimleyici

Vegetable Slicer

Kod Code	Model Model	Koli/Adet Pcs/Ctn
77505610	Gövde/Body	1
77505611	5 mm Dilim/Slice	1

» Sebze Meyve Dilimleyici İkiye Bölücü

Semi-Circle Slicer

Kod Code	Model Model	Koli/Adet Pcs/Ctn
77505610	Gövde/Body	1
77505629	5 mm Dilim-İkiye bölücü/ 5 mm Semi-circle Slice	1

59

- Meyvelerin göbeklerini kolayca çıkararak 8 dilime böler
- Maksimum meyve çapı Ø 90 (mm)
- Maksimum göbek çapı Ø 25 (mm)
- *To easily core and slice fresh apples and pears into 8 segments*
- *Maximum diameter of fruit Ø 90 mm*
- *Core diameter Ø 25 mm*

- Ekstra keskin bıçaklar patateslerin kusursuz kesimini sağlar
- Pürüzsüz kesim patatesin pişirken fazla yağ çekmesini engeller
- *With its perfectly sharp blades, it cuts potatoes into neat french fries without tears to avoid the absorption of oil during cooking*
- *Grid format 90 x 90 mm*

- Dikdörtgen kesim patateslerinize ev yapımı görüntüsü verir
- Pürüzsüz kesim patatesin pişirken fazla yağ çekmesini engeller
- *Easily cut fresh potatoes into rectangles for "home-made" chips*
- *Chips are cut cleanly into 8 x 16mm rectangles with no tears*



» Meyve Doğrayıcı Göbek Çıkarıcı

Fruit Corer Segmenter

Kod Code	Model Model	Koli/Adet Pcs/Ctn
77505610	Gövde/Body	1
77505619	8 Dilim/8 Corer-segmentes	1

» Patates Dilimleyici

French Fries Cutter

Kod Code	Model Model	Koli/Adet Pcs/Ctn
77505610	Gövde/Body	1
77505626	8x8 mm Dilim/Segment	1
77505627	10x10 mm Dilim/Segment	1

» Dikdörtgen Patates Dilimleyici

Rectangular French Fries Cutter

Kod Code	Model Model	Koli/Adet Pcs/Ctn
77505610	Gövde/Body	1
77505628	8x16 mm Dilim/Segment	1



» Püre Makinesi

Food Mill

Kod Code	Ölçü (cm) Dim. (cm)	Koli/Adet Pcs/Ctn
62050037	37	1

* Fiyata süzgeçler dahil değildir.
* W/o sieve

» Püre Makinesi Süzgeçleri

Sieve for Food Mill

Kod Code	Delik Ø (mm) Hole Ø (mm)	Koli/Adet Pcs/Ctn
62050001	1	1
62050015	1,5	1
62050002	2	1
62050003	3	1
62050004	4	1

» Püre Makinesi 3 Süzgeçli

Food Mill w/3 Sieves

Kod Code	Ölçü (cm) Dim (cm)	Koli/Adet Pcs/Ctn
62050031	31	1

* Süzgeçlerin delik çapları 1,5, 2,5 ve 4 mm'dir.
** Fiyata süzgeçler dahildir.
* Sieves: 1,5, 2,5 ve 4 mm
** w/ Sieves

60



» Tezgah Tip Konserveler Açacağı

Manuel Can Opener

Kod Code	Model Model	Koli/Adet Pcs/Ctn
41030004	Endüstriyel Industrial	1
41130004	Alüminyum Aluminum	1
41230004	Paslanmaz Çelik Stainless Steel	1



» Çekmeceli Ekmek Kesim

Bread Cutting Board w/Drawer

Kod Code	Koli/Adet Pcs/Ctn
49000006	1



» Hamburger Şekillendirici

Hamburger Press

Kod Code	Model Model	Koli/Adet Pcs/Ctn
41040010	Şekillendirici 10 cm Press w/10 cm	1
41040012	Hazne 12 cm Chamber 12 cm	1
41040014	Hazne 14 cm Chamber 14 cm	1

* 10 cm hazne Şekillendirici fiyatına dahildir.
** Diğer hazneler opsiyoneldir.
* w/10 cm chamber
** Other chambers not included



» Tavuk Makası
Poultry Shears

Kod Code	Koli/Adet Pcs/Ctn
40010057	4



» Çok Amaçlı Mutfak Makası
Multi-Purpose Kitchen Scissors

Kod Code	Koli/Adet Pcs/Ctn
83010002	4



» Konserve Açacağı
Can Opener

Kod Code	Koli/Adet Pcs/Ctn
40010044	6



» Ceviz Kıracağı
Nut Cracker (S/S)

Kod Code	Koli/Adet Pcs/Ctn
62040006	4



» Sarmısak Ezici
Garlic Press (S/S)

Kod Code	Koli/Adet Pcs/Ctn
62040007	2

61



» Peynir Dilimleyici
Cheese Slicer

Kod Code	Koli/Adet Pcs/Ctn
40010031	6



» Yumuşak Peynir Bıçağı
Soft Cheese Knife

Kod Code	Koli/Adet Pcs/Ctn
40010032	6



» Dışli Parizyen Kaşık

Tomato Corer

Kod Code	Koli/Adet Pcs/Ctn
83010004	6



» Oval Parizyen Kaşık

Oval Melon Baller

Kod Code	Koli/Adet Pcs/Ctn
83010005	6



» Oval Tırtıklı Parizyen Kaşık

Ribbed Oval Melon Baller

Kod Code	Koli/Adet Pcs/Ctn
83010006	6



» Parizyen Kaşık

Melon Baller

Kod Code	Ø (mm) Ø (mm)	Koli/Adet Pcs/Ctn
83010010	10	6



» Parizyen Kaşık

Melon Baller

Kod Code	Ø (mm) Ø (mm)	Koli/Adet Pcs/Ctn
83010015	15	6



» Parizyen Kaşık

Melon Baller

Kod Code	Ø (mm) Ø (mm)	Koli/Adet Pcs/Ctn
83010022	22	6



» Parizyen Kaşık

Melon Baller

Kod Code	Ø (mm) Ø (mm)	Koli/Adet Pcs/Ctn
83010025	25	6



» Parizyen Kaşık

Melon Baller

Kod Code	Ø (mm) Ø (mm)	Koli/Adet Pcs/Ctn
83010030	30	6



» Dışli Rulet

Pastry Wheel

Kod Code	Koli/Adet Pcs/Ctn
83010007	6



» Açacak ve Kabuk Şekillendirici

Decorator

Kod Code	Koli/Adet Pcs/Ctn
40010042	6



» Üçgen Dekoratör

Triangular Decorator

Kod Code	Koli/Adet Pcs/Ctn
83010008	6



» “V” Dekoratör

“V” Shaped Decorator

Kod Code	Koli/Adet Pcs/Ctn
83010009	6



» Narenciye Şekilendirici (Tek Delik)

Lemon Striper w/One Hole

Kod Code	Koli/Adet Pcs/Ctn
-------------	----------------------

83010031	6
----------	---



» Greyfurt Bıçağı

Grapefruit Knife

Kod Code	Koli/Adet Pcs/Ctn
-------------	----------------------

83010032	6
----------	---



» Narenciye Bıçağı

Citrus Knife

Kod Code	Koli/Adet Pcs/Ctn
-------------	----------------------

83010033	6
----------	---



» Meyve Şekillendirici

Decorator

Kod Code	Koli/Adet Pcs/Ctn
-------------	----------------------

40010033	6
----------	---



» Tereyağ Çekici

Butter Curler

Kod Code	Koli/Adet Pcs/Ctn
-------------	----------------------

40010030	6
----------	---



» Dekorator

Decorator (S/S)

Kod Code	Koli/Adet Pcs/Ctn
-------------	----------------------

62050013	2
----------	---

63



» Kabak Oyacak

Zucchini Corer

Kod Code	Koli/Adet Pcs/Ctn
-------------	----------------------

83010035	6
----------	---



» Elma Oyacağı

Apple Corer

Kod Code	Koli/Adet Pcs/Ctn
-------------	----------------------

40010043	6
----------	---



» Sebze Soyacak

Peeler

Kod Code	Koli/Adet Pcs/Ctn
-------------	----------------------

40010029	6
----------	---

Termometreler / Thermometers

- 0+300°C
- S/S Delici Çubuk/S/S Probe :150 mm
- Ø : 50 mm



» Pişirme/Kızartma Termometresi
Cooking & Frying Thermometer

Kod Code	Koli/Adet Pcs/Ctn
62060001	2



- +54 +88 °C / +130 +190 °F
- S/S Delici Çubuk/S/S Probe :145 mm
- Ø : 50 mm



» Et Termometresi
Meat Thermometer

Kod Code	Koli/Adet Pcs/Ctn
62060006	2



- +50 +300 °C / +100 +600 °F
- Paslanmaz çelik gövde/S/S Body
- Ø : 83 mm
- Mikrodalga fırınlarda kullanılmaz/
Do not use in microwave oven



» Fırın Termometresi
Dial Oven Thermometer

Kod Code	Koli/Adet Pcs/Ctn
62060008	2



64

- -30 +30 °C / -20 +80 °F
- Paslanmaz çelik gövde/S/S Body
- Ø : 50 mm
- Fırın ve Mikrodalga fırınlarda kullanılmaz
Do not use in oven and microwave oven



» Buzdolabı Termometresi
Fridge/Freezer Thermometer

Kod Code	Koli/Adet Pcs/Ctn
62060007	2

- -50 +70 °C / -58 +158 °F
- Kablo : 1 m/Cable : 1 m
- Miknatis/Magnetic back
- Max-mini. programlanabilir alarm
Maxi-mini - Programmable alarm only
- Alarm kapatılana kadar çalar
Stop ringing if it is turned off



» Dijital Buzdolabı Termometresi
Digital Fridge Thermometer

Kod Code	Koli/Adet Pcs/Ctn
62060002	2

- 19 saat - 59 dakika zamanlayıcı
Timer 19 h - 59 m
- 19 saat - 59 dakika kronometre
Stopwatch 19 h - 59 m
- Alarm
- Miknatsız ve Standlı / Magnetic back
/ Free Standing



» Dijital Zamanlayıcı Saat
Digital Timer

Kod Code	Koli/Adet Pcs/Ctn
62060009	2

- Pişirme anında ısı kontrolü
- Kremalar, karamelize soslar ve çikolata için ideal
- 220 °C'ye kadar dayanıklı sap
- Çıkarılabilir termometre
- Termometre -20° + 200°C
- 385 mm uzunluk
- Su geçirmez
- Bulaşık makinasında yıkanmaya uygun değildir

- Control the temperature of your dish during cooking, while mixing at the same time
- Ideal for creams, caramelized sugar, chocolate
- Handle resists up to 220°C, dishwasher safe
- Removable thermometer -20° to +200°C, precision 0.1°C, reliability to 1°C
- 385 mm length
- Tight against water splashing, not suitable for dishwasher



» Spatula Termometre

Spatula Thermometer

Kod Code	Koli/Adet Pcs/Ctn
77503090	1

- +80 +200°C
- Kademeli daldırma 70 mm
- Civasız kırmızı gösterge
- +/- 350 mm uzunluk
- Paslanmaz çelik koruma kabı
- Fırın ve Mikrodalga fırınlarda kullanılmaz

- +80 +200°C
- Partial immersion 70 mm
- In glass-red liquid filled
- +/- 350 mm length
- w/Stainless Steel protection sleeve
- Not suitable for ovens and microwaves



» Şeker Termometresi

Sugar Thermometer

Kod Code	Koli/Adet Pcs/Ctn
62060003	2

65

- -50+200°C / -58+392°F
- Suya dayanıklı/Waterproof
- S/S Delici Çubuk/Probe :125 mm

- -50+200°C / -58+392°F
- Suya dayanıklı/Waterproof
- S/S Delici Çubuk/Probe :125 mm

- -50+530°C / -58+986°F
- Uzaklık değeri/Distance Ratio : 12/1
- LCD Ekran / LCD Screen



» Dijital Çok Amaçlı Cep Termometresi

Digital Pocket Thermometer

Kod Code	Koli/Adet Pcs/Ctn
43030121	6

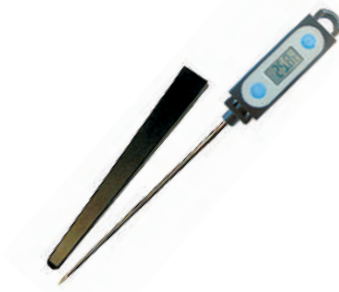

» Dijital Cep Termometresi

Digital Pocket Thermometer

Kod Code	Koli/Adet Pcs/Ctn
62060004	6



» Kızılötesi Termometre (Lazer Göstergeli)

Infrared Thermometer

Kod Code	Koli/Adet Pcs/Ctn
62060005	1



» Hassas Terazi
Digital Scale

Kod Code	Kapasite Capacity	Hassasiyet Accuracy	Ölçü (cm) Dim. (cm)	Koli/Adet Pcs/Ctn
65010010	10 Kg	1 g	14,5x14,5	3



» Hassas Terazi
Digital Scale

Kod Code	Kapasite Capacity	Hassasiyet Accuracy	Ölçü (cm) Dim. (cm)	Koli/Adet Pcs/Ctn
65010025	25 Kg	1 g	17,5x20	3



» Hassas Terazi
Digital Scale

Kod Code	Kapasite Capacity	Hassasiyet Accuracy	Ölçü (cm) Dim. (cm)	Koli/Adet Pcs/Ctn
65010015	15 Kg	0,5 g	18x21,5	1
65010030	30 Kg	1 g	18x21,5	1



» Hassas Terazi
Digital Scale

Kod Code	Kapasite Capacity	Hassasiyet Accuracy	Ölçü (cm) Dim. (cm)	Koli/Adet Pcs/Ctn
65010003	3 Kg	0,5-1 g	17,6x22,3	1

66



» Mekanik İbrelili Terazi
Mechanical Scale

Kod Code	Kapasite Capacity	Hassasiyet Accuracy	Koli/Adet Pcs/Ctn
65010020	20 Kg	50 g	1



» Baskül
Receiving Digital Scale

Kod Code	Kapasite Capacity	Ölçü (cm) Dim. (cm)	Koli/Adet Pcs/Ctn
65010150	150 Kg	40x50	1
65010300	300 Kg	60x70	1



» Ölçülü Mayonez Kabı
Calibrated Mixing Bowl

Kod Code	Øxh (cm) Øxh (cm)	Koli/Adet Pcs/Ctn
35050016	16x8	4
35050020	20x10	4
35050024	24x12	4
35050030	30x15	2
35050036	36x18	2



» Konik Ölçülü Kap
Calibrated Conical Bowl

Kod Code	Øxh (cm) Øxh (cm)	Koli/Adet Pcs/Ctn
62015020	20	6
62015024	24	6
62015028	28	6
62015032	32	4
62015036	36	4
62015040	40	1
62015045	45	1



» Çelik Kova Ölçülü
Calibrated Bucket (S/S)

Kod Code	Lt Lt	Koli/Adet Pcs/Ctn
52020012	1	1



» Ölçülü Maşrapa
Calibrated Bain-Marie Pot

Kod Code	Øxh (cm) Øxh (cm)	Koli/Adet Pcs/Ctn
35701416	14x16	2
35701618	16x18	2
35701820	18x20	2
35702022	20x22	2



» Polikarbonat Ölçme Kabı
PC Measuring Cup

Kod Code	Lt Lt	Koli/Adet Pcs/Ctn
60021001	1	6
60021002	2	6
60021003	3	4
60021005	5	4



» Polipropilen Ölçme Kabı
PP Measuring Cup

Kod Code	Lt Lt	Koli/Adet Pcs/Ctn
43031001	0,5	6
43031002	1	6
43031003	2	6
43031004	3	6
43031006	5	6



» Ölçü Kabı
Measuring Cup

Kod Code	Lt Lt	Koli/Adet Pcs/Ctn
62010001	1	6
62010002	2	6



» Dörtlü Ölçek Seti
Measuring Cup Set

Kod Code	Koli/Adet Pcs/Ctn
40010058	6
*1/4 - 1/3 - 1/2 - 1/1 Cup	



» Dörtlü Ölçü Kaşık Seti
Measuring Spoon Set

Kod Code	Koli/Adet Pcs/Ctn
40010059	6
*2,5 cc - 5 cc - 7,5 cc - 15 cc	



» Sos Hunisi

Sauce Fun

Kod Code	Koli/Adet Pcs/Ctn
62010019	1

* İki farklı kalınlıkta akıtma ağzı seçeneği.
* Includes two interchangeable tips.



» Yumurta Çemberi Yuvarlak

Egg Ring Round

Kod Code	Ölçü (cm) Dim. (cm)	Koli/Adet Pcs/Ctn
62010039	Ø 10	10



» Yumurta Çemberi Kare

Egg Ring Square

Kod Code	Ölçü (cm) Dim. (cm)	Koli/Adet Pcs/Ctn
62010029	10x10	10

68



» Rende Kalın
Grater Coarse

Kod Code	Koli/Adet Pcs/Ctn
83100030	6



» Rende Ekstra Kalın
Grater Extra Coarse

Kod Code	Koli/Adet Pcs/Ctn
83100040	6



» Rende Ribbon
Grater Ribbon

Kod Code	Koli/Adet Pcs/Ctn
83100010	6



» Rende Shaver
Grater Shaver

Kod Code	Koli/Adet Pcs/Ctn
83100020	6



» Piramit Rende
Grater

Kod Code	Koli/Adet Pcs/Ctn
44013300	6



» Endüstriyel Rende
Industrial Grater

Kod Code	Koli/Adet Pcs/Ctn
44013301	6



» Sipariş Tutucu (Bilyeli)

Tickets-holder

Kod Code	Ölçü (cm) Dim. (cm)	Koli/Adet Pcs/Ctn
62010061	61	6



» Şef Cımbızı

Chef's Tong

Kod Code	Ölçü (mm) Dim. (mm)	Model Model	Koli/Adet Pcs/Ctn
77502913	145x10	Düz/Straight	6
77502021	180x25	Belli/Angular	6
77500025	250	Düz/Straight	6



» Karıştırıcı Palet (Paslanmaz)

Mixing Spatula (S/S)

Kod Code	Ölçü (cm) Dim. (cm)	Koli/Adet Pcs/Ctn
62010142	107	1



» Patates Ezici (Paslanmaz)

Potato Masher (S/S)

Kod Code	Ölçü (cm) Dim. (cm)	Koli/Adet Pcs/Ctn
62010128	71	1



» Dekor Kaşık Seti (2'li)

Deco Spoon Set (2 Spoons)

Kod Code	Ø (mm) Ø (mm)	h (mm) h (mm)	Koli/Adet Pcs/Ctn
77506436	75	55	1



» Şaşula (Paslanmaz)

Scoop (S/S)

Kod Code	Kapasite (gr) Capacity (gr)	Koli/Adet Pcs/Ctn
44014301	100	6
44014302	135	6
44014303	250	6
44014304	380	6
44014305	560	6



» Düz Şaşula (Polikarbonat)

PC Scoop

Kod Code	Model Model	Koli/Adet Pcs/Ctn
46010116	Düz/Plain	24
46010117	Delikli/Perforated	24

plast|port
by KAPP



» Pataşu (Polietilen)

Spatula (Polyethylene)

Kod Code	Ölçü (cm) Dim. (cm)	Koli/Adet Pcs/Ctn
49000030	30	1
49000035	35	1
49000045	45	1
49000055	55	1
49000065	65	1
49000075	75	1
49000100	100	1
49000120	120	1



» Havan (Polietilen)
Mortar (Polyethylene)

Kod Code	Model Model	Koli/Adet Pcs/Ctn
49020002	Küçük/Small	1
49020003	Orta/Medium	1
49020004	Büyük/Big	1



» Bal Tokmagı (Polietilen)
Honey Spoon (Polyethylene)

Kod Code	Koli/Adet Pcs/Ctn
49020010	1



» Balık Pulu Temizleyicisi (Polietilen)
Fish Scale Cleaner (Polyethylene)

Kod Code	Koli/Adet Pcs/Ctn
49020020	1



» Un Elek (Paslanmaz)
Sieve (S/S)

Kod Code	Ø (cm) Ø (cm)	Koli/Adet Pcs/Ctn
44013025	25	2
44013030	30	2
44013040	40	2



» Kalbur (Paslanmaz)
Grate (S/S)

Kod Code	Ø (cm) Ø (cm)	Koli/Adet Pcs/Ctn
44013125	25	2
44013130	30	2
44013140	40	2



» Un Elek (S/S)
Flour Sifter (S/S)

Kod Code	Koli/Adet Pcs/Ctn
43133000	2

70



» Helvane Süzgeç
Colander

Kod Code	Ø (cm) Ø (cm)	Koli/Adet Pcs/Ctn
30423609	36x9	3
30423812	38x12	3
30424512	45x12	3
30425012	50x12	2
30426012	60x14	2
30427014	70x14	2
30428016	80x16	1



» Süzgeç Kaçarola
Colander for Sauce Pan

Kod Code	Ø (cm) Ø (cm)	Koli/Adet Pcs/Ctn
31380005	20x13	2
31380006	24x15	2
31380020	28x17	2



» Çelik Süzgeç
Colander

Kod Code	Ø (cm) Ø (cm)	Koli/Adet Pcs/Ctn
62010028	28	4
62010032	32	4
62010036	36	2
62010040	40	2



» Exoglass Konik Sık Süzgeç
Exoglass Bouillon Strainer

Kod Code	Ø (cm) Ø (cm)	Koli/Adet Pcs/Ctn
77507360	20x22	1

Dengeyi kuvvetlendiren 2'li kanca
2 hooks for stability

Güçlü monoblok gövde ve sap
Body and handle made of one- piece
composite material

3 kademe sık paslanmaz çelik süzgeç
Triple fine stainless steel triple mesh



Monoblok ergonomik sap
One-piece ergonomic handle
Rahat ve ısı yalıtımlı
Comfortable heat insulating handle

Destekli paslanmaz çelik
Stainless steel wire reinforcement



» Çin Külâhi
Chinese Colander

Kod Code	Ø (cm) Ø (cm)	Koli/Adet Pcs/Ctn
62010016	16	4
62010020	20	4
62010024	24	2



» Konik Sos Süzgeci Destekli
S/S Bouillon Strainer

Kod Code	Ø (cm) Ø (cm)	Koli/Adet Pcs/Ctn
62011290	22x23	1



» Konik Süzgeç
Conical Strainer

Kod Code	Ø (cm) Ø (cm)	Koli/Adet Pcs/Ctn
62013016	16	6
62014020	20	6



» Baharat Shaker
Shaker

Kod Code	Ölçü (cm) Dim. (cm)	Model Model	Koli/Adet Pcs/Ctn
62021789	7	Büyük Delikli Big Hole	6
62023789	7	Küçük Delikli Small Hole	6
62022789	7	Süzgeç Mesh	6



» Makarna Pişirme Süzgeci
1/4-Segment Pasta Colander

Kod Code	Ölçü (cm) Dim. (cm)	Koli/Adet Pcs/Ctn
36302420	24x19,5 Tencere ile uyumlu Suitable for 24x19,5 Pot	3
36303623	36x22 Tencere ile uyumlu Suitable for 36x22 Pot	4
36304026	40x25 Tencere ile uyumlu Suitable for 40x25 Pot	4



» Huni (Süzgeçli)
Funnel w/Strainer

Kod Code	Ölçü (cm) Dim. (cm)	Koli/Adet Pcs/Ctn
62010475	12	4
62010550	14	4



» Derin Kepçe Sık (Paslanmaz)

Round Strainer (S/S)

Kod Code	Ölçü (cm) Dim. (cm)	Koli/Adet Pcs/Ctn
44013424	24	6
44013427	27	6
44013430	30	6



» Derin Kepçe Seyrek (Paslanmaz)

Coarse Round Strainer (S/S)

Kod Code	Ölçü (cm) Dim. (cm)	Koli/Adet Pcs/Ctn
44013324	24	6
44013327	27	6
44013330	30	6



» Tel Süzgeç (Paslanmaz)

Round Strainer (S/S)

Kod Code	Ölçü (cm) Dim. (cm)	Koli/Adet Pcs/Ctn
62010018	18	6
62010022	22	6
62010026	26	6



» Tel Kevgir Sık (Paslanmaz)

Mesh Skimmer (S/S)

Kod Code	Ölçü (cm) Dim. (cm)	Koli/Adet Pcs/Ctn
44013217	17	6
44013222	22	6
44013227	27	6
44013230	30	6



» Tel Kevgir Seyrek (Paslanmaz)

Coarse Mesh Skimmer (S/S)

Kod Code	Ölçü (cm) Dim. (cm)	Koli/Adet Pcs/Ctn
44013817	17	6
44013822	22	6
44013827	27	6
44013830	30	6



» Kevgir Kalın (Lokma Kevgiri)

Wire Skimmer S/S (Heavy Duty)

Kod Code	Ölçü (cm) Dim. (cm)	Koli/Adet Pcs/Ctn
62016020	20	4
62016024	24	4
62016028	28	2



» Tencere Teli (Paslanmaz)

Strainer for Pot (S/S)

Kod Code	Ölçü (cm) Dim. (cm)	Koli/Adet Pcs/Ctn
44013015	30x15	2
44014020	40x20	2
44015020	50x20	2
44016020	60x20	2
44017030	70x30	1
44018030	80x30	1



» Tava Teli (Paslanmaz)

Strainer for Pan (S/S)

Kod Code	Ölçü (cm) Dim. (cm)	Koli/Adet Pcs/Ctn
44014011	40x11	2
44015012	50x12	2
44016014	60x14	2
44017015	70x15	1
44018016	80x16	1

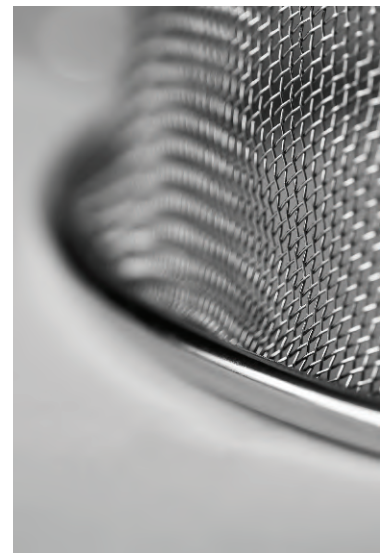



» Askılı Çırpıcı (Paslanmaz)

Wire Whip (S/S)

Kod Code	Ölçü (cm) Dim. (cm)	Koli/Adet Pcs/Ctn
40010061	25	6
40010062	30	6
40010063	35	6
40010064	40	4
40010065	45	4
40010066	50	4
40010067	55	2
40010068	60	2

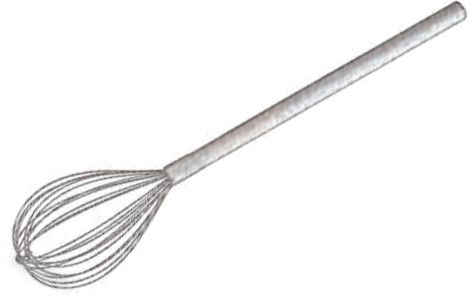

» Çırpma Teli (Krom)

Balloon Whisk (Chrome Plated)

Kod Code	Ölçü (cm) Dim. (cm)	Koli/Adet Pcs/Ctn
44010274	74	1
44010298	98	1
44012120	120	1



» Çırpıcı

Whisk

Kod Code	Ölçü (cm) Dim. (cm)	Koli/Adet Pcs/Ctn
62020031	31	6
62020036	36	6
62020041	41	4
62020046	46	2
62020051	51	2



» Yumurta Çırpıcı

Egg Whisk

Kod Code	Ölçü (cm) Dim. (cm)	Koli/Adet Pcs/Ctn
40010071	10	6
40010072	20	6



» Piyano Çırpıcı (Paslanmaz)

Whisk (S/S)

Kod Code	Ölçü (cm) Dim. (cm)	Koli/Adet Pcs/Ctn
40010069	25	6
40010070	35	6

Spatulalar / Spatulas



» Yanmaz Spatula

Heat-Resistant Spatula

Kod Code	Ölçü (cm) Dim. (cm)	Koli/Adet Pcs/Ctn
77503025	25	6
77503030	30	6
77503035	35	4
77503040	40	4
77503045	45	2
77503050	50	2



» Yanmaz Spatula

Heat-Resistant Spatula

Kod Code	Ölçü (cm) Dim. (cm)	Koli/Adet Pcs/Ctn
62012500	25	4
62013500	35	4
62014500	40	4



74



» Pasta Spatula

Pastry Spatula

Kod Code	Ölçü (cm) Dim. (cm)	Koli/Adet Pcs/Ctn
62013025	25	4
62013030	30	4
62013035	35	2



» Belli Pasta Spatula

Angular Spatula

Kod Code	Ölçü (cm) Dim. (cm)	Koli/Adet Pcs/Ctn
62010025	25	4



» Spatula

Spatula

Kod Code	Ölçü (cm) Dim. (cm)	Koli/Adet Pcs/Ctn
62010010	10	4
62010013	13	4
62010015	15	4



» Geniş Spatula

Wide Spatula

Kod Code	Ölçü (cm) Dim. (cm)	Koli/Adet Pcs/Ctn
62012020	20	4
62011025	25	4



» Geniş Spatula Delikli

Perforated Wide Spatula

Kod Code	Ölçü (cm) Dim. (cm)	Koli/Adet Pcs/Ctn
62012025	25	4



» Pizza Küreği

Pizza Spatula

Kod Code	Ölçü (cm) Dim. (cm)	Model Model	Koli/Adet Pcs/Ctn
62010008	17	Normal Plain	4
62010014	17	Delikli Perforated	4



» Servis Spatula (Paslanmaz)
Serving Spatula (S/S)

Kod Code	Ölçü (cm) Dim. (cm)	Koli/Adet Pcs/Ctn
62010011	25	6



» Spatula (Paslanmaz Saplı)
Spatula (S/S Handle)

Kod Code	Ölçü (cm) Dim. (cm)	Koli/Adet Pcs/Ctn
44020001	6,5x11	6
44020002	8x12	6
44020003	10x13,5	6
44020004	11x16	6
44020005	13x17	6



» Pasta Paleti (Paslanmaz Saplı)
Pastry Spatula (S/S Handle)

Kod Code	Ölçü (cm) Dim. (cm)	Koli/Adet Pcs/Ctn
44020101	20x3,5	6
44020102	25x3,5	6
44020103	30x3,5	6



» Pasta Bıçağı (Paslanmaz Saplı)
Pastry Knife (S/S Handle)

Kod Code	Ölçü (cm) Dim. (cm)	Koli/Adet Pcs/Ctn
44020201	20x3,5	6
44020202	25x3,5	6
44020203	30x3,5	6



» Dişli Pasta Bıçağı (Paslanmaz Saplı)
Pastry Knife (S/S Handle)

Kod Code	Ölçü (cm) Dim. (cm)	Koli/Adet Pcs/Ctn
44020301	20x3,5	6
44020302	25x3,5	6
44020303	30x3,4	6



» Pizza Küreği (Paslanmaz Saplı)
Pizza Spatula (S/S Handle)

Kod Code	Ölçü (cm) Dim. (cm)	Koli/Adet Pcs/Ctn
44020006	16x4x13,5	6



» Pizza Ruleti
Pizza Roulette

Kod Code	Ölçü (cm) Dim. (cm)	Koli/Adet Pcs/Ctn
62010021	10	6



» Hamur Kazıyıcısı (Paslanmaz Saplı)
Dough Scraper (S/S Handle)

Kod Code	Ölçü (cm) Dim. (cm)	Koli/Adet Pcs/Ctn
62010006	13x11	6



490 491 492 493 494 495



» Polietilen Kesim Levhaları

Cutting Boards

Kod Code	Ölçü (cm) Dim. (cm)	Koli/Adet Pcs/Ctn
49050404	25x40x4	1
49030404	30x40x4	1
49030504	30x50x4	1
49030604	40x60x4	1
49025402	25x40x2	1
49030402	30x40x2	1
49030502	30x50x2	1
49063202	32,5x26,5x2	1
49025302	32,5x53x2	1
49060402	60x40x2	1



» Kesim Levhası (GN 1/1 Küvet ile uyumlu)

Cutting Board for GN Pan

Kod Code	Model Model	Koli/Adet Pcs/Ctn
49020030	GN 1/1-100 Küvet için Cutting Board for GN 1/1 Pan	1

* GN küvet fiyata dahil değildir.

* w/o G/N Pan.

76



» Kesim Levhası İstif Teli (6 Bölmeli)

Cutting Board Rack S/S (6 Partitioned)

Kod Code	Ölçü (cm) Dim. (cm)	Koli/Adet Pcs/Ctn
62021885	30,5x26,5x26,5	1

* 2 cm kalınlığındaki levhalara uygundur.

* Suitable for 2mm cutting board

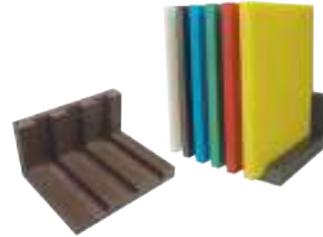

» Polietilen İstif Rafı

Storing Shelf for Cutting Board

Kod Code	Kalınlık (cm) Thickness (cm)	Koli/Adet Pcs/Ctn
49000002	2	1
49000004	4	1



» Polietilen Levha Temizleme Bıçağı

Board Scraper (Polyethylene)

Kod Code	Koli/Adet Pcs/Ctn
49000003	1





Riveted Chef's Knives Perçinli Şef Bıçakları

Çiftli veya üçlü perçinli ergonomik saplar profesyonel mutfaklarda güvenli kullanım sağlar.

Ergonomics

The double- or triple- rivetted outer or solid material handle provides a safe grip when working in a professional kitchen

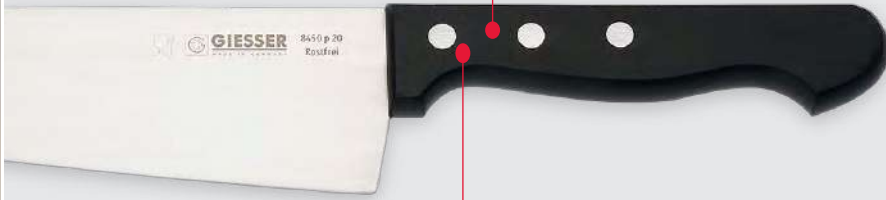

Güçlendirilmiş plastikten (POM polioksimetilen) üretilen saplar gıdayla temasa uygundur.

Pom

Polyoxymethylene is a dimensionally stable and rigid plastic that naturally meets the requirements of the Federal Food and Commodities Regulation



» Şef Bıçağı

Chef's Knife

Kod
Code

Ölçü (cm)
Dim. (cm)

60512000

20

60512600

26

78



» Soyma Bıçağı

Paring Knife

Kod
Code

Ölçü (cm)
Dim. (cm)

60518500

8,5



» Çok Amaçlı Bıçak

Multi Purpose Knife

Kod
Code

Ölçü (cm)
Dim. (cm)

60511500

15



» Ekmek Bıçağı

Bread Knife

Kod
Code

Ölçü (cm)
Dim. (cm)

60512400

24



» Kemik Sıyırma Bıçağı

Boning Knife

Kod
Code

Ölçü (cm)
Dim. (cm)

60511510

13



» Kasap Bıçağı

Butcher Knife

Kod
Code

Ölçü (cm)
Dim. (cm)

60512100

21



» Jambon Bıçağı

Ham Knife

Kod
Code

Ölçü (cm)
Dim. (cm)

60512500

25

* Bıçaklar tekli satılmaktadır * Knives are sold individually



» Şef Bıçağı
Chef's Knife

Kod Code	Ölçü (cm) Dim. (cm)
60521600	16
60522000	20
60522300	23
60522600	26
60523100	31



» Kasap Bıçağı
Butcher Knife

Kod Code	Ölçü (cm) Dim. (cm)
60521800	18
60522100	21
60522400	24
60522700	27
60523000	30



» Kemik Sıyırma Bıçağı
Boning Knife

Kod Code	Ölçü (cm) Dim. (cm)
60521400	14
60521610	16



» Dişli Ekmek Bıçağı
Bread Knife Wavy Edge

Kod Code	Ölçü (cm) Dim. (cm)
60521210	21



» Dişli Belli Ekmek Bıçağı
Bread Knife Wavy Edge Angular

Kod Code	Ölçü (cm) Dim. (cm)
60521230	23



» Çok Amaçlı Bıçak
Multi Purpose Knife

Kod Code	Ölçü (cm) Dim. (cm)
60522130	13
60522160	16
60522180	18
60522210	21



» Balık Bıçağı
Fish Knife

Kod Code	Model Model	Ölçü (cm) Dim. (cm)
60522181	Balık/Fish	18
60523210	Balık/Fish	21
60524210	Somon/Salmon	21



» Mıknatıslı Bıçaklık
Magnetic Board

Kod Code	Ölçü (cm) Dim. (cm)
60500002	64



» Bıçak Rulosu
Knife Bag

Kod Code	Model Model
60500001	7 Bölmeli 7 Segments

* Bıçaklar tekli satılmaktadır * Knives are sold individually



80



» Şef Bıçağı Monoblok

Cook's Knife Monoblock

Kod Code	Ölçü (cm) Dim. (cm)	Koli/Adet Pcs/Ctn
44020029	29	6
44020031	31	6
44020033	33	6
44020035	35	6



» Kaşar Bıçağı Monoblok

Ham Knife Monoblock

Kod Code	Ölçü (cm) Dim. (cm)	Koli/Adet Pcs/Ctn
44020042	42	6
44020047	47	6



» Börek Bıçağı

Pastry & Pie Knife

Kod Code	Ölçü (cm) Dim. (cm)	Koli/Adet Pcs/Ctn
44020022	22	6
44020023	23	6
44020024	24	6



» Soğan Bıçağı

Onion Knife

Kod Code	Ölçü (cm) Dim. (cm)	Koli/Adet Pcs/Ctn
44021031	31	6

* Ölçüler sap hariçtir * Dimensions do not include handles



» Krom Şef Bıçağı

Chrome Cook's Knife

Kod Code	Ölçü (cm) Dim. (cm)	Koli/Adet Pcs/Ctn
45000026	17	6
45000027	19	6
45000028	21	6



» Sebze Bıçağı

Paring Knife

Kod Code	Ölçü (cm) Dim. (cm)	Koli/Adet Pcs/Ctn
45091041	9	6
45091042	12	6
45091043	13	6



» Kasap Bıçağı

Butcher Knife

Kod Code	Ölçü (cm) Dim. (cm)	Koli/Adet Pcs/Ctn
45091000	12,5	6
45091001	14,5	6
45091002	16,5	6
45091003	19	6
45091004	21	6
45091008	25	6



» Ekmek Bıçağı

Bread Knife

Kod Code	Ölçü (cm) Dim. (cm)	Koli/Adet Pcs/Ctn
45091052	15,5	6
45091053	17,5	6



» Kemik Sıyırma Bıçağı

Boning Knife

Kod Code	Ölçü (cm) Dim. (cm)	Koli/Adet Pcs/Ctn
45091005	12,5	6
45091006	14,5	6
45091007	16,5	6



» Doğrama Bıçağı

Chopping Knife

Kod Code	Ölçü (cm) Dim. (cm)	Koli/Adet Pcs/Ctn
45000001	14	6
45000002	16	6
45000003	18	6
45000004	20	6



» Lakerda Bıçağı

Fish Filleting Knife

Kod Code	Ölçü (cm) Dim. (cm)	Koli/Adet Pcs/Ctn
45091091	25	6



» Jambon Bıçağı

Ham Knife

Kod Code	Ölçü (cm) Dim. (cm)	Koli/Adet Pcs/Ctn
45000007	30	6



» Dişli Ekmek Bıçağı

Bread Knife

Kod Code	Ölçü (cm) Dim. (cm)	Koli/Adet Pcs/Ctn
45041023	19,5	6



* Ölçüler sap hariçtir * Dimensions do not include handles





» Şef Bıçağı
Cook's Knife

Kod Code	Ölçü (cm) Dim. (cm)	Koli/Adet Pcs/Ctn
45091160	19	6
45091161	21	6
45091162	23	6



» Peynir Bıçağı
Cheese Knife

Kod Code	Ölçü (cm) Dim. (cm)	Koli/Adet Pcs/Ctn
45091070	13,5	6
45091071	15,5	6
45091072	17,5	6



» Döner Bıçağı
Doner Kebab Knife

Kod Code	Ölçü (cm) Dim. (cm)	Koli/Adet Pcs/Ctn
45071004	55	6



82



» Baklava Bıçağı
Pastry Knife

Kod Code	Ölçü (cm) Dim. (cm)	Koli/Adet Pcs/Ctn
45091171	16	6



» Kaymak Bıçağı
Heavy Cream Knife

Kod Code	Ölçü (cm) Dim. (cm)	Koli/Adet Pcs/Ctn
45091172	19	6



» Börek Bıçağı
Pastry & Pie Knife

Kod Code	Ölçü (cm) Dim. (cm)	Koli/Adet Pcs/Ctn
45071080	16,5	6
45071082	20	6



» Balıkçı Bıçağı
Fisher Knife

Kod Code	Ölçü (cm) Dim. (cm)	Koli/Adet Pcs/Ctn
45091151	35	2



» Kaşar Bıçağı
Ham Knife

Kod Code	Ölçü (cm) Dim. (cm)	Koli/Adet Pcs/Ctn
45000005	35	1



» Kaşar Bıçağı (Çift Saplı)
Ham Knife (Double Handled)

Kod Code	Ölçü (cm) Dim. (cm)	Koli/Adet Pcs/Ctn
45000006	30	1

* Ölçüler sap hariçtir * Dimensions do not include handles



» Pizza Bıçağı
Pizza Knife

Kod Code	Ölçü (cm) Dim. (cm)	Koli/Adet Pcs/Ctn
45071120	26	1



» Dekor Seti
Decoration Knife Set

Kod Code	Koli/Adet Pcs/Ctn
45041330	1

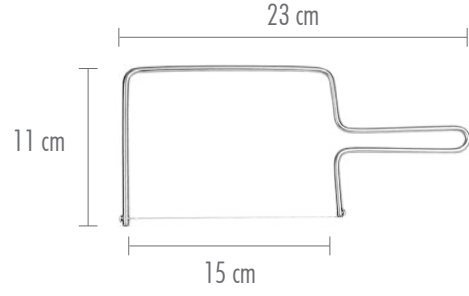

» Peynir Kesici
Cheese Slicer

Kod Code	Ölçü (cm) Dim. (cm)	Koli/Adet Pcs/Ctn
62050017	15	4

* Yedek tel ürüne dahildir

* Replacement wire included



» Yuvarlak Masat
Sharpening Steel (Round)

Kod Code	Ölçü (cm) Dim. (cm)	Koli/Adet Pcs/Ctn
45081083	12	6



» Yassı Masat
Sharpening Steel

Kod Code	Ölçü (cm) Dim. (cm)	Koli/Adet Pcs/Ctn
45081088	12	6



» Et Açma Bıçağı
Filleting Knife

Kod Code	Ölçü (cm) Dim. (cm)	Koli/Adet Pcs/Ctn
45000030	30	1
45000035	35	1

83



» Yuvarlak Masat
Skewer (S/S)

Kod Code	Ölçü (cm) Dim. (cm)	Koli/Adet Pcs/Ctn
45081152	60	12



» Adana Şiş (Galvaniz)
Skewer (Galvanized)

Kod Code	Ölçü (cm) Dim. (cm)	Koli/Adet Pcs/Ctn
45081153	60	12

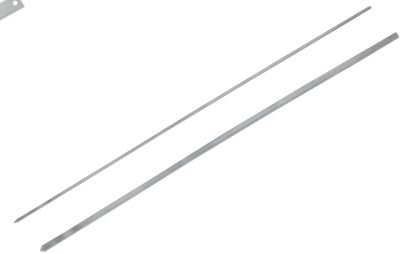

» Kare Şiş (Paslanmaz)
Skewer Square (S/S)

Kod Code	Ölçü (cm) Dim. (cm)	Koli/Adet Pcs/Ctn
45081167	3x3 mm 60 cm	12
45081166	5x5 mm 60 cm	12

* Ölçüler sap hariçtir * Dimensions do not include handles



» Satır
Cleaver

Kod Code	Ölçü (cm) Dim. (cm)	Koli/Adet Pcs/Ctn
45061111	20	1
45061112	23	1



» Uzun Saplı Satır
Cleaver w/Long Handle

Kod Code	Ölçü (cm) Dim. (cm)	No No	Koli/Adet Pcs/Ctn
45000009	20	1	1
45000010	24	2	1
45000011	29	3	1



» Tavuk Satır
Poultry Cleaver

Kod Code	Ölçü (cm) Dim. (cm)	Koli/Adet Pcs/Ctn
45000008	19	1



» Soğan Satır
Onion Knife

Kod Code	Ölçü (cm) Dim. (cm)	Koli/Adet Pcs/Ctn
45061060	19	1



» Dövme Zırh (Siyah Çelik)
Black Hammered Mincing Knife

Kod Code	Ölçü (cm) Dim. (cm)	Koli/Adet Pcs/Ctn
45000012	30	1
45000014	40	1
45000015	50	1



» Paslanmaz Zırh
Mincing Knife (S/S)

Kod Code	Ölçü (cm) Dim. (cm)	Koli/Adet Pcs/Ctn
45000018	30	1
45000020	40	1
45000022	50	1

84



» Et Döveceği (Polietilen)
Meat Tenderiser (Polyethylene)

Kod Code	Ölçü (cm) Dim. (cm)	Koli/Adet Pcs/Ctn
49000005	40	4



» Et Döveceği (Paslanmaz)
Meat Tenderiser (S/S)

Kod Code	Koli/Adet Pcs/Ctn
62010017	4



» Et Döveceği
Meat Tenderiser

Kod Code	Koli/Adet Pcs/Ctn
45000036	4



» Çift Saplı Zırh

Mincing Knife w/Double Handles

Kod Code	Ölçü (cm) Dim. (cm)	Koli/Adet Pcs/Ctn
45000024	25	1
45000025	30	1

* Ölçüler sap hariçtir

* Dimensions do not include handles



» Et Çengeli

Meat Hook

Kod Code	Ölçü (cm) Dim. (cm)	Koli/Adet Pcs/Ctn
62020010	10	12
62020015	15	12
62020025	25	12



» Et Çengeli

Meat Hook

Kod Code	Ölçü (cm) Dim. (cm)	Model Model	Koli/Adet Pcs/Ctn
45081040	8	Nikel Nickel	12
45081056	8	Krom Chrome	12



» Çelik Örgü Eldiven

S/S Chainmail Butcher Glove

Kod Code	Ölçü (cm) Dim. (cm)	Koli/Adet Pcs/Ctn
65600010	Small	1
65610010	Medium	1
65620010	Large	1
65630010	X-Large	1

* Ters yüz giyilebilir. * Reverse side can be wearable



» Çelik Örgü Uzun Eldiven

S/S Chainmail Shoulder Butcher Glove

Kod Code	Koli/Adet Pcs/Ctn
65600012	1



» Kesilmeye Dirençli Eldiven

Cut Resistant Glove

Kod Code	Koli/Adet Pcs/Ctn
65600011	1



» Çelik Örgü Önlük

S/S Chainmail Butcher Apron

Kod Code	Ölçü (cm) Dim. (cm)	Koli/Adet Pcs/Ctn
65605660	55x70<1,65 m	1
65605670	56x80>1,65 m	1



» Mıknatıslı Bıçaklık

Magnetic Board

Kod Code	Ölçü (cm) Dim. (cm)	Koli/Adet Pcs/Ctn
45081205	50	6
60500002	64	1



» Bıçak Sterilizatörü

Knife Sterilizer

Kod Code	Model Model	Koli/Adet Pcs/Ctn
45000037	10 Bıçaklı / 10 Division	1

Pastacılık/Pastry







88 >> Yuvarlak Kalıp Kelepçeli
Springform Mould

Kod Code	Ø (cm) Ø (cm)	Koli/Adet Pcs/Ctn
64010240	24	2
64010260	26	2
64010280	28	2

>> Tart Kalıbı Yuvarlak
Round Tart Mould w/Flat Edge (Fluted)

Kod Code	Ø (cm) Ø (cm)	h (mm) h (mm)	Koli/Adet Pcs/Ctn
64012825	280/250	30	2



>> Tart Kalıbı Sık Yıvli (Çıkarılabilir Taban)
Round Fluted Mould (Loose Bottom, Narrow Ribs)

Kod Code	Ø (cm) Ø (cm)	h (mm) h (mm)	Koli/Adet Pcs/Ctn
64011080	100/80	30	2
64011513	150/130	40	2
64012017	200/170	45	2

>> Tart Kalıbı Yuvarlak (Çıkarılabilir Taban)
Medium Deep Fluted Mould (Loose Bottom)

Kod Code	Ø (cm) Ø (cm)	h (mm) h (mm)	Koli/Adet Pcs/Ctn
64012018	200/185	25	2
64012423	240/230	25	2
64012827	280/270	25	2

>> Yuvarlak Kalıp
Round Plain Mould

Kod Code	Ø (cm) Ø (cm)	h (mm) h (mm)	Koli/Adet Pcs/Ctn
64012120	200/175	50	2
64012124	240/210	50	2
64013295	320/295	55	2



» Gondol Kalıp Yivli
Fluted Oval Boat Mould

Kod Code	Ölçü (mm) Dim. (mm)	Koli/Adet Pcs/Ctn
64018040	80x40	12



» Gondol Kalıp Düz
Plain Oval Boat Mould

Kod Code	Ölçü (mm) Dim. (mm)	Koli/Adet Pcs/Ctn
64016020	60x20	12
64018033	80x33	12
64011043	100x43	12
64011350	120x50	12



» Brioche Kalıp
Brioche Mould

Kod Code	Ölçü (mm) Dim. (mm)	Koli/Adet Pcs/Ctn
64016028	60x28	12
64011055	100x55	12



» Kubbe Yivli Mini Kalıp
Ribbed Dome Mini Mould

Kod Code	Ölçü (mm) Dim. (mm)	Koli/Adet Pcs/Ctn
64010045	45	12



» Oval Yivli Mini Kalıp
Ribbed Oval Mini Mould

Kod Code	Ölçü (mm) Dim. (mm)	Koli/Adet Pcs/Ctn
64110045	45	12



» Kare Yivli Mini Kalıp
Ribbed Square Mini Mould

Kod Code	Ölçü (mm) Dim. (mm)	Koli/Adet Pcs/Ctn
64210045	35x35	12



» Yuvarlak Yivli Tart Kalıbı Seti 4'lü
Set of 4 Fluted Round Canele

Kod Code	Ø (mm) Ø (mm)	Koli/Adet Pcs/Ctn
43030732	120	3



» Yuvarlak Yivli Tart Kalıbı
Fluted Round Canele

Kod Code	Ø (mm) Ø (mm)	Koli/Adet Pcs/Ctn
64310045	45	12
64310060	60	12
64310100	100	12
64310120	120	12



» Dariole Kalıp

Dariole/Rum Baba Mould

Kod Code	Ø (mm) Ø (mm)	Koli/Adet Pcs/Ctn
64010060	60	12



» Sufle Kalıp

Souffle Mould

Kod Code	Ø (mm) Ø (mm)	Koli/Adet Pcs/Ctn
64010080	80	3



» Dikdörtgen Mini Kalıp

Friand Mould

Kod Code	Ölçü (mm) Dim. (mm)	h (mm) h (mm)	Koli/Adet Pcs/Ctn
64210035	98x51	14	12



» Ekmek Kalıbı

Loaf Mould

Kod Code	Ölçü (cm) Dim. (cm)	h (cm) h (cm)	Koli/Adet Pcs/Ctn
43030733	25x11	6,4	2
43030734	30x11	6,4	2

90

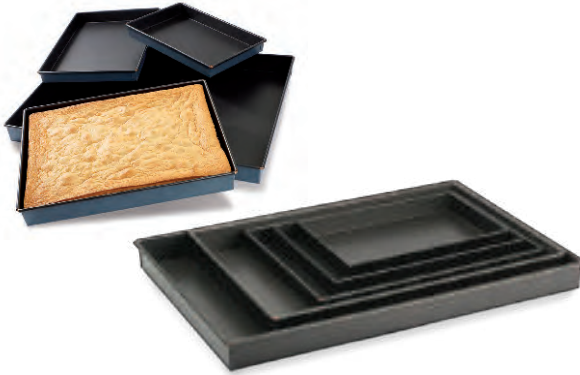

» Pişirme Tepsisi

Baking Sheet

Kod Code	Ölçü (mm) Dim. (mm)	h (mm) h (mm)	Koli/Adet Pcs/Ctn
64014035	400x300	35	2
64014050	400x300	50	2



» Tost Ekmek Kalıbı

Toastbrot w/Lid

Kod Code	Ölçü (mm) Dim. (mm)	Koli/Adet Pcs/Ctn
64012500	250x76	2
64010400	400x90	2



» Fashion Éclair
Fashion Éclair

Kod Code	Ölçü (mm) Dim. (mm)	Kapasite Capacity
43030093	125x25x25	10x8 ml



» Finger Éclair
Finger Éclair

Kod Code	Ölçü (mm) Dim. (mm)	Kapasite Capacity
43030110	130x27x27	8x9,2 ml



» Pillow
Pillow

Kod Code	Ölçü (mm) Dim. (mm)	Kapasite Capacity
43030100	82x43x32	9x8,2 ml



» Stone
Stone

Kod Code	Ölçü (mm) Dim. (mm)	Kapasite Capacity
43030102	Ø 60x30	8x10,5 ml



» Cacao
Cacao

Kod Code	Ölçü (mm) Dim. (mm)	Kapasite Capacity
43030101	102x57x42	6x19 ml



» Swirl
Swirl

Kod Code	Ölçü (mm) Dim. (mm)	Kapasite Capacity
43030088	Ø 68xh 30	60x400 ml



91



» Mini-Savarin
Mini Savarin

Kod Code	Ölçü (mm) Dim. (mm)	Kapasite Capacity
43030092	Ø 41x12	77x12 ml



» Quenelle
Quenelle

Kod Code	Ölçü (mm) Dim. (mm)	Kapasite Capacity
43030103	63x31x28	48x24 ml



NEW



» Eclips
Eclips

Kod Code	Ölçü (mm) Dim. (mm)	Kapasite Capacity
43030064	Ø 70x37	28x100 ml



» Disk İnce
Disco Thin

Kod Code	Ölçü (mm) Dim. (mm)	Kapasite Capacity
43030122	Ø 120x10	12x112 ml



» Disk
Disco

Kod Code	Ölçü (mm) Dim. (mm)	Kapasite Capacity
43030123	Ø 120x22	12x120 ml

92



» Yarım Küre Mini
Half Sphere Mini

Kod Code	Ölçü (mm) Dim. (mm)	Kapasite Capacity
43030060	Ø 35x17,5	96x11 ml



» Brioche
Brioche

Kod Code	Ölçü (mm) Dim. (mm)	Kapasite Capacity
43030051	Ø 79x35	24x84 ml



» Kalp Mini
Mini Heart

Kod Code	Ölçü (mm) Dim. (mm)	Kapasite Capacity
43030062	36x39x16	70x11 ml



» Muffin Büyük
Muffin Big

Kod Code	Ölçü (mm) Dim. (mm)	Kapasite Capacity
43030096	73x40	24x125 ml



» Muffin Mini
Muffin Mini

Kod Code	Ölçü (mm) Dim. (mm)	Kapasite Capacity
43030055	51x29	40x45 ml



» Muffin
Muffin

Kod Code	Ölçü (mm) Dim. (mm)	Kapasite Capacity
43030067	40x20	48x25 ml

* Silikon kalıplar tekli satılmaktadır * Silicone moulds are sold individually

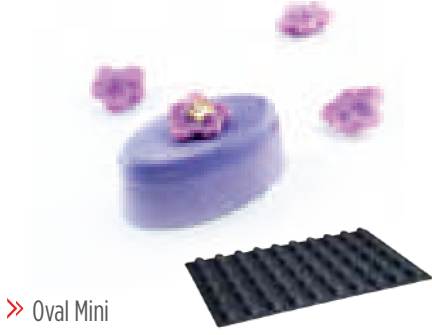

» Oval Mini
Oval Mini

Kod Code	Ölçü (mm) Dim. (mm)	Kapasite Capacity
43030068	52x32x20	50x25 ml



» Fiorentin Disk
Fiorentin Disk

Kod Code	Ölçü (mm) Dim. (mm)	Kapasite Capacity
43030053	60x12	35x33,5 ml



» Madlen Mini
Madlen Mini

Kod Code	Ölçü (mm) Dim. (mm)	Kapasite Capacity
43030061	45x26	100x12 ml



» Dörtgen Mini
Square Mini

Kod Code	Ölçü (mm) Dim. (mm)	Kapasite Capacity
43030054	86x46x25	25x110 ml



» Piramit
Pyramid

Kod Code	Ölçü (mm) Dim. (mm)	Kapasite Capacity
43030058	65x35	35x61 ml



» Mekik
Mekik

Kod Code	Ölçü (mm) Dim. (mm)	Kapasite Capacity
43030066	107x45x15	30x35 ml

93



» Kalp
Heart

Kod Code	Ölçü (mm) Dim. (mm)	Kapasite Capacity
43030094	82x90x50	20x130 ml



» Sufle
Souffle

Kod Code	Ölçü (mm) Dim. (mm)	Kapasite Capacity
43030080	44x28	40x28 ml



» Elips Sticks
Elips Sticks

Kod Code	Ölçü (mm) Dim. (mm)	Kapasite Capacity
43030189	495x40	5x450 ml



» Yarım Küre 5'li
Half Sphere 5 Pcs.

Kod Code	Øxh (mm) Øxh (mm)	Kapasite (ml) Capacity (ml)
43030012	80x40	5x120 ml



» Yarım Küre 6'lı
Half Sphere 6 Pcs.

Kod Code	Øxh (mm) Øxh (mm)	Kapasite (ml) Capacity (ml)
43030013	70x35	6x80 ml



» Yarım Küre 6'lı
Half Sphere 6 Pcs.

Kod Code	Øxh (mm) Øxh (mm)	Kapasite (ml) Capacity (ml)
43030014	60x30	6x80 ml



94

» Yarım Küre 8'li
Half Sphere 8 Pcs.

Kod Code	Øxh (mm) Øxh (mm)	Kapasite (ml) Capacity (ml)
43030015	50x25	8x30 ml



» Yarım Küre 15'li
Half Sphere 15 Pcs.

Kod Code	Øxh (mm) Øxh (mm)	Kapasite (ml) Capacity (ml)
43030016	40x20	15x20 ml



» Yarım Küre 24'lü
Half Sphere 24 Pcs.

Kod Code	Øxh (mm) Øxh (mm)	Kapasite (ml) Capacity (ml)
43030017	30x15	24x10 ml



» Muffin Mini 11'li
Muffin Mini 11 Pcs.

Kod Code	Øxh (mm) Øxh (mm)	Kapasite (ml) Capacity (ml)
43030021	51x28	11x50 ml



» Muffin Orta 6'lı
Medium Muffin 6 Pcs.

Kod Code	Øxh (mm) Øxh (mm)	Kapasite (ml) Capacity (ml)
43030022	69x35	6x100 ml



» Oval 16'li
Oval 16 Pcs.

Kod Code	Øxh (mm) Øxh (mm)	Kapasite (ml) Capacity (ml)
43030020	55x33x20	16x30 ml



» Gül Mini 15'li
Mini Rose 15 Pcs.

Kod Code	Øxh (mm) Øxh (mm)	Kapasite (ml) Capacity (ml)
43030034	44x27	15x23 ml



» Mekik Orta 12'li
Medium Boat 12 Pcs.

Kod Code	Øxh (mm) Øxh (mm)	Kapasite (ml) Capacity (ml)
43030028	72x30	12x20 ml



» Mekik Büyük 9'lu
Big Boat 9 Pcs.

Kod Code	Øxh (mm) Øxh (mm)	Kapasite (ml) Capacity (ml)
43030029	100x44	9x40 ml



» Kalp Büyük 6'lı
Big Heart 6 Pcs.

Kod Code	Øxh (mm) Øxh (mm)	Kapasite (ml) Capacity (ml)
43030027	65x40	6x130 ml



» Kalp Küçük 10'lu
Small Heart 10 Pcs.

Kod Code	Øxh (mm) Øxh (mm)	Kapasite (ml) Capacity (ml)
43030032	48x54	10x45 ml



» Kalp Orta 8'li
Medium Heart 8 Pcs.

Kod Code	Øxh (mm) Øxh (mm)	Kapasite (ml) Capacity (ml)
43030071	60x35	8x90 ml

95

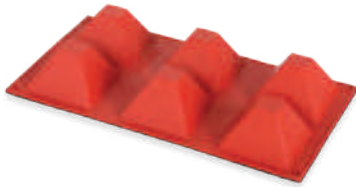

» Piramit 6'lı
Pyramid 6 Pcs.

Kod Code	Øxh (mm) Øxh (mm)	Kapasite (ml) Capacity (ml)
43030018	71x71	6x90 ml



» Macaron Silpatı
Macaron Baking Sheet

Kod Code	Øxh (mm) Øxh (mm)	Kapasite (ml) Capacity (ml)
43035000	40x60	70 bölme 70 partition

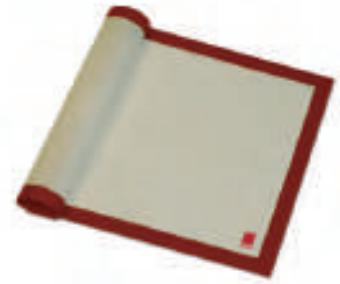

» Fiber Örtü Silpat
Baking Sheet

Kod Code	Ölçü (cm) Dim. (cm)	Koli/Adet Pcs/Ctn
43030069	40x60	6

Çikolata Kalıpları / Chocolate Moulds



» Kaşık Çikolata Kalıbı
Spoon Chocolate Mould

Kod Code	Ölçü (mm) Dim. (mm)	Kapasite Capacity
43032001	275x135	10x20 gr



» Kare Sargılı Çikolata Kalıbı
Square Chocolate Mould

Kod Code	Ölçü (mm) Dim. (mm)	Kapasite Capacity
43032002	275x135	10x20 gr



» Çizgili Elips Çikolata Kalıbı
Rib Oval Chocolate Mould

Kod Code	Ölçü (mm) Dim. (mm)	Kapasite Capacity
43032003	275x135	24x15 gr

96



» Elmas Çikolata Kalıbı
Diomands Chocolate Mould

Kod Code	Ölçü (mm) Dim. (mm)	Kapasite Capacity
43032004	275x135	21x14 gr



» Çelenk Çikolata Kalıbı
Wreath Chocolate Mould

Kod Code	Ölçü (mm) Dim. (mm)	Kapasite Capacity
43032005	275x135	21x10 gr



» Çikolatin Kalıbı
Roses Chocolate Mould

Kod Code	Ölçü (mm) Dim. (mm)	Kapasite Capacity
43032006	275x135	24x8 gr

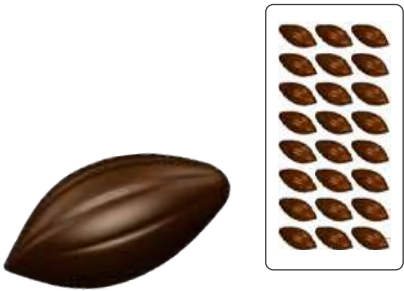

» Kakao Çikolata Kalıbı
Cacao Chocolate Mould

Kod Code	Ölçü (mm) Dim. (mm)	Kapasite Capacity
43032007	275x135	24x10 gr

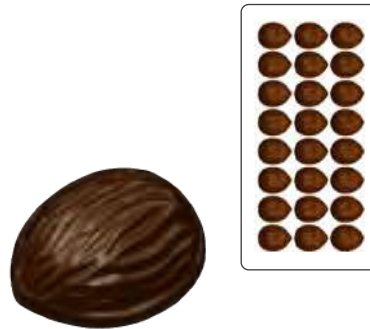

» Ceviz Çikolata Kalıbı
Walnut Chocolate Mould

Kod Code	Ölçü (mm) Dim. (mm)	Kapasite Capacity
43032008	275x135	24x8 gr

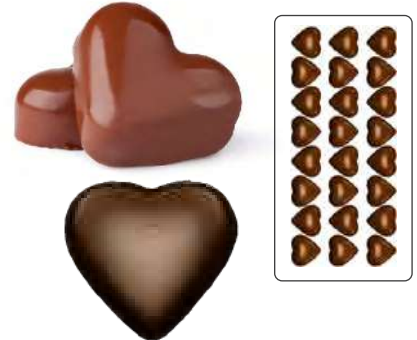

» Bombeli Kalp Çikolata Kalıbı
Heart Chocolate Mould

Kod Code	Ölçü (mm) Dim. (mm)	Kapasite Capacity
43032009	275x135	24x13 gr

* Çikolata Kalıpları tekli satılmaktadır * Chocolate moulds are sold individually



» Büyük Kestane Çikolata Kalıbı
Big Chocolate Mould

Kod Code	Ölçü (mm) Dim. (cm)	Kapasite Capacity
43032010	275x135	21x13 gr



» Küçük Kestane Çikolata Kalıbı
Small Scallop Chocolate Mould

Kod Code	Ölçü (mm) Dim. (cm)	Kapasite Capacity
43032012	275x135	24x13 gr

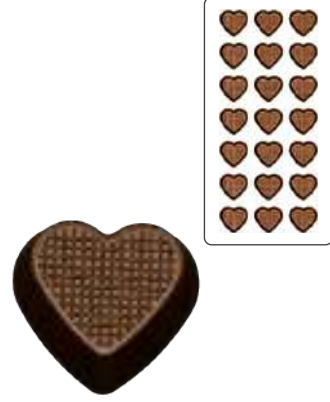

» Ekose Kalp Çikolata Kalıbı
Patterned Heart Chocolate Mould

Kod Code	Ölçü (mm) Dim. (cm)	Kapasite Capacity
43032011	275x135	21x11 gr

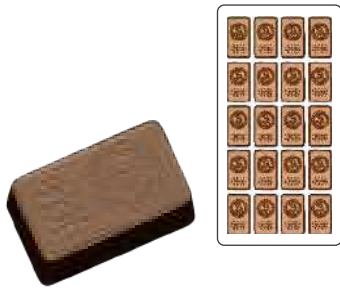

» Altın Külçe Çikolata Kalıbı
Gold Ingot Chocolate Mould

Kod Code	Ölçü (mm) Dim. (cm)	Kapasite Capacity
43032013	275x135	20x17 gr

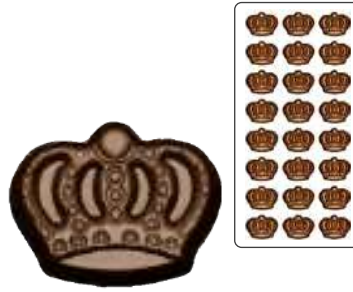

» Taç Çikolata Kalıbı
Crown Chocolate Mould

Kod Code	Ölçü (mm) Dim. (cm)	Kapasite Capacity
43032014	275x135	24x14 gr

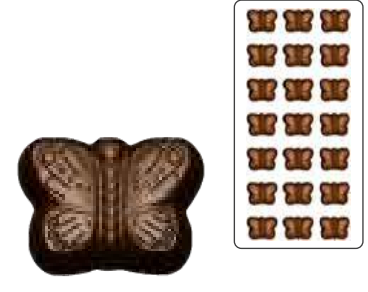

» Kelebek Çikolata Kalıbı
Butterfly Chocolate Mould

Kod Code	Ölçü (mm) Dim. (cm)	Kapasite Capacity
43032015	275x135	21x10 gr

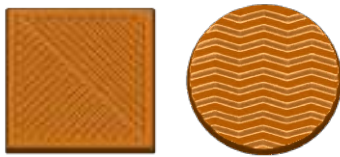

» Madlen Çikolata Kalıbı
Cubic Chocolate Mould

Kod Code	Ölçü (mm) Dim. (cm)	Model Model
43032019	43x43x6 gr	Yuvarlak Round
43032020	40x40x 6 gr	Kare Square

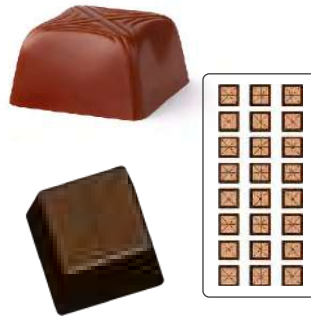

» Küp Çikolata Kalıbı
Cubic Chocolate Mould

Kod Code	Ölçü (mm) Dim. (cm)	Kapasite Capacity
43032017	275x135	24x12,5 gr



» Etekli Elips Çikolata Kalıbı
Ribbed Elips Chocolate Mould

Kod Code	Ölçü (mm) Dim. (cm)	Kapasite Capacity
43032016	275x135	24x13 gr

- Şoka dayanıklı Polipropilen gövde
- Sökülebilir paslanmaz çelik iç hazne
- Çikolatayı eritir ve sıvı halde kalmasını sağlar
- Özel rezistansı sayesinde homojen ısı dağılımı
- 25-90°C ısı aralığı
- Yalıtımlı gövde maksimum enerji tasarrufu sağlar
- Ağırlık : 1,8 Kg

- Multi-Purpose appliance for melting and keeping chocolate, fondant, toppings, sauces, jelly, etc.
- Non detachable stainless steel bowl
- Heat is uniformly distributed thanks to a special resistor
- Electronic regulation 25 to 90°C for a wide range of uses. Accuracy $\pm 1,5^{\circ}\text{C}$
- Reduced energy consumption thanks to efficient insulation
- Weight: 1.8 kg



» Yuvarlak Çikolata Eritme Makinesi

Chocolate Melting Machine

Kod Code	Øxh (mm) Øxh (mm)	Kapasite Capacity	Koli/Adet Pcs/Ctn
77550010	254x188	3,5 Lt	1

98

NEW



» Çikolata Firkete Takımı

Chocolate Dipping Forks

Kod Code	Model Model	Koli/Adet Pcs/Ctn
43230010	10'lü/10 pcs	1

NEW

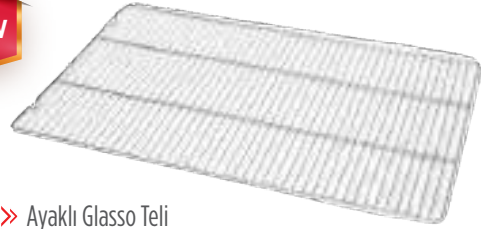

» Ayaklı Glasso Teli

Cooling Rack

Kod Code	Ölçü(cm) Dims.(cm)	Koli/Adet Pcs/Ctn
43034060	40x60	1



» Çikolata Püskürtme Makinası

Chocolate Spray Gun

Kod Code	Koli/Adet Pcs/Ctn
43031050	1

NEW



» Çikolata Spatulası

Chocolate Spatula

Kod Code	Ölçü (cm) Dim. (cm)	Koli/Adet Pcs/Ctn
43031051	20	1



» Çember h: 5 cm
Cake Rings h:5 cm

Kod Code	Ø (cm) Ø (cm)	Koli/Adet Pcs/Ctn
43030508	8	6
43030510	10	6
43030514	14	6
43030516	16	6
43030518	18	3
43030520	20	3
43030522	22	3
43030524	24	3
43030526	26	3
43030528	28	3



» Çember h: 7 cm
Cake Rings h:7 cm

Kod Code	Ø (cm) Ø (cm)	Koli/Adet Pcs/Ctn
43030708	8	6
43030710	10	6
43030714	14	6
43030716	16	6
43030718	18	3
43030720	20	3
43030722	22	3
43030724	24	3
43030726	26	3
43030728	28	3



» Ayarlı Çember (Çelik)
Adjustable Ring

Kod Code	Ölçü (cm) Dim. (cm)	Koli/Adet Pcs/Ctn
43030010	15-30	1



» Kare Kalıp h: 7 cm
Square Rings h: 7 cm

Kod Code	Ölçü (cm) Dim. (cm)	Koli/Adet Pcs/Ctn
43031710	10x10	6
43031713	13x13	6
43031715	15x15	6
43031717	17x17	6
43031719	19x19	3
43031722	22x22	3
43031724	24x24	3
43031726	26x26	3
43031728	28x28	3
43031730	30x30	3



» Kare Kalıp h: 10 cm
Square Rings h: 10 cm

Kod Code	Ölçü (cm) Dim. (cm)	Koli/Adet Pcs/Ctn
43031010	10x10	6
43031013	13x13	6
43031015	15x15	6
43031017	17x17	6
43031019	19x19	3
43031022	22x22	3
43031024	24x24	3
43031026	26x26	3
43031028	28x28	3
43031030	30x30	3



» Ayarlı Dörtgen Kalıp (Çelik)
Adjustable Cake Mould

Kod Code	Ölçü (cm) Dim. (cm)	Koli/Adet Pcs/Ctn
43030007	20-40	1
43030006	30-60	1
43030009	20-40	1
43030008	30-60	1

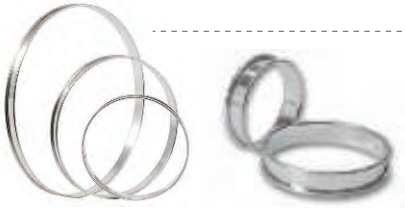

» Tart Çemberi (Kıvrık Kenarlı)
S/S Tart Ring Rolled Edges

Kod Code	Ölçü (cm) Dim. (cm)	Koli/Adet Pcs/Ctn
77507016	70x16	6
77501420	140x20	6
77501820	180x20	6
77502020	200x20	6



» Kalp Kalıp
Heart

Kod Code	Ölçü (mm) Dim. (mm)	h (mm) h (mm)	Koli/Adet Pcs/Ctn
64018585	85x85	30	6



» Oblong Kalıp
Oblong

Kod Code	Ölçü (mm) Dim. (mm)	h (mm) h (mm)	Koli/Adet Pcs/Ctn
64011140	110x40	110x40	6



» Yuvarlak Metal Volovan 6'lı Set
Round Cutter Steel Set of 6

Kod Code	Ölçü (mm) Dim. (mm)	Koli/Adet Pcs/Ctn
43030105	Dişli/Fluted	1
43030104	Düz/Plain	1



» Kare Metal Volovan 6'lı Set
Square Cutter Steel Set of 6

Kod Code	Ölçü (mm) Dim. (mm)	Koli/Adet Pcs/Ctn
43030107	Dişli/Fluted	1
43030106	Düz/Plain	1



» Kalp Metal Volovan 6'lı Set
Heart Cutter Steel Set of 6

Kod Code	Ölçü (mm) Dim. (mm)	Koli/Adet Pcs/Ctn
43030109	Dişli/Fluted	1
43030108	Düz/Plain	1

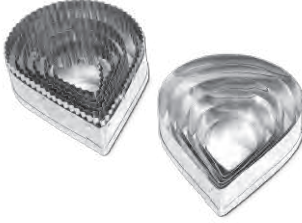

» Damla Metal Volovan 6'lı Set
Drop Cutter Steel Set of 6

Kod Code	Ölçü (mm) Dim. (mm)	Koli/Adet Pcs/Ctn
43030112	Dişli/Fluted	1
43030111	Düz/Plain	1



» Dörtgen Metal Volovan 6'lı Set
Diamond Cutter Steel Set of 6

Kod Code	Ölçü (mm) Dim. (mm)	Koli/Adet Pcs/Ctn
43030114	Dişli/Fluted	1
43030113	Düz/Plain	1



» Oval Metal Volovan 6'lı Set
Oval Cutter Steel Set of 6

Kod Code	Ölçü (mm) Dim. (mm)	Koli/Adet Pcs/Ctn
43030116	Dişli/Fluted	1
43030115	Düz/Plain	1

100



» Ayarlı Rulet Çift Taraflı
Dough Wheel Multi Cut

Kod Code	Model Model	Koli/Adet Pcs/Ctn
43030049	5'li 5 Wheels	1
43030050	7'li 7 Wheels	1



» Kafes Kesici Rulet
Pastry Roller

Kod Code	Koli/Adet Pcs/Ctn
77501110	4



» Delici Rulet
Spiked Pastry Roller

Kod Code	Koli/Adet Pcs/Ctn
77501120	4



» Kabartma Kabi
Cream Whipper

Kod Code	Kapasite Capacity	Koli/Adet Pcs/Ctn
43030045	0,5 Lt	1
43030046	1,0 Lt	1
43030047	10x8 gr Kabartma Tüpü 10x8 gr Cream Charger	1

* 1 kabartma tüpü ile 0,5 litreye kadar krema ve benzeri ürünler hazırlanabilir.
* One cream charger whips up to 0.5 litres of liquid whipping cream or similar product.

NEW



» Tekstil Eldiven
Oven Mitt

Kod Code	Ölçü (cm) Dim. (cm)	Koli/Adet Pcs/Ctn
43130006	Uzun Long	4



» Yanmaz Eldiven
Leather Glove (Over Wrist)

Kod Code	Koli/Adet Pcs/Ctn
43030005	4



» Silikon Eldiven Uzun **silikowart**
Silicone Glove professional

Kod Code	Koli/Adet Pcs/Ctn
43130004	4



» 12'li Duy Seti (PC)
Icing Tip Set 12 pcs. (PC)

Kod Code	Koli/Adet Pcs/Ctn
43030073	1



» 12'li Duy Seti (Plastik)
Icing Tip Set 12 pcs. (Plastic)

Kod Code	Koli/Adet Pcs/Ctn
43030072	1



» 52'li Duy Seti (Paslanmaz Çelik)
Icing Tip Set 52 Ocs. (S/S)

Kod Code	Koli/Adet Pcs/Ctn
43031008	1

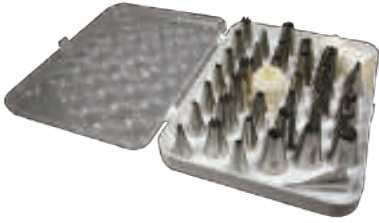

» Büyük Boy Duy Seti 36'lı (S/S)
Icing Tip Big Set 36 Ocs.(S/S)

Kod Code	Koli/Adet Pcs/Ctn
43031009	1



» Krema Torbası
Pastry Bag



Kod Code	Ölçü (cm) Dim. (cm)	Koli/Adet Pcs/Ctn
43030038	40	6
43030039	46	6
43030040	50	6
43030041	55	6
43030042	60	6
43030043	65	6



» Krema Torbası Tek Kullanımlık 72'li
Pastry Bag 72 Pcs.

Kod Code	Ölçü (cm) Dim. (cm)	Koli/Adet Pcs/Ctn
43030044	50x26	6

102



» Pürmüz
Torch

Kod Code	Koli/Adet Pcs/Ctn
43030048	



» Un Elek (S/S)
Flour Sifter (S/S)

Kod Code	Koli/Adet Pcs/Ctn
43133000	2



» Kakao/Pudra Şekeri Shaker
Shaker

Kod Code	Model Model	Koli/Adet Pcs/Ctn
62021789	Büyük Delikli 7 cm Big Hole 7 cm	6
62023789	Küçük Delikli 7 cm Small Hole 7 cm	6
62022789	Süzgeç 7 cm Mesh 7 cm	6



» Spatula Termometre
Spatula Thermometer

Kod Code	Ölçü (cm) Dim. (cm)	Koli/Adet Pcs/Ctn
77503090	38,5	1



» Şeker Termometresi
Sugar Thermometer

Kod Code	Koli/Adet Pcs/Ctn
62060003	1



» Pandispanya Testeresi
Genoese Saw

Kod Code	Model Model	Koli/Adet Pcs/Ctn
43031052	2 Testere Set of 2 Spared Blades	1



» Kruvasan Merdane
Croissant Roller Cutter

Kod Code	Ölçü (cm) Dim. (cm)	Koli/Adet Pcs/Ctn
49270430	43x8	1



» Merdane (Paslanmaz)
Roller (S/S)

Kod Code	Ölçü (cm) Dim. (cm)	Koli/Adet Pcs/Ctn
44020007	50	1



» Oklava (Polietilen)
Rollin Pin (Polyethylene)

Kod Code	Ölçü (cm) Dim. (cm)	Koli/Adet Pcs/Ctn
49020025	Ø 25	1
49010035	Ø 35	1



» Saplı Merdane (Polietilen)
Roller (Polyethylene)

Kod Code	Ölçü (cm) Dim. (cm)	Model Model	Koli/Adet Pcs/Ctn
49070250	Ø 7x25+20	Küçük Small	1
49080330	Ø 8x33+20	Orta Medium	1
49098380	Ø 9x38+20	Büyük Big	1



» Fırça (Sentetik)
Brush

Kod Code	No No	Koli/Adet Pcs/Ctn
43600001	1	6
43600002	2	6
43600003	3	6



» Sos/Surup Dökücü
Pouring Container

Kod Code	Lt Lt	Koli/Adet Pcs/Ctn
60020001	1	4
60020002	2	4



» BO Şurupluk
BO

Kod Code	ml ml	Koli/Adet Pcs/Ctn
43030075	500	6
43030076	1000	6



» Sos Hunisi
Sauce Gun

Kod Code	Koli/Adet Pcs/Ctn
62010019	1



» Ölçülü Maşrapa
Calibrated Bain-Marie Pot

Kod Code	Øxh (cm) Øxh (cm)	Koli/Adet Pcs/Ctn
35701416	14x16	2
35701618	16x18	2
35701820	18x20	2
35702022	20x22	2



» Polikarbonat Ölçme Kabı
PC Measuring Cup

Kod Code	Lt Lt	Koli/Adet Pcs/Ctn
60021001	1	6
60021002	2	6
60021003	3	4
60021005	5	4



» Polipropilen Ölçme Kabı
PC Measuring Cup

Kod Code	Lt Lt	Koli/Adet Pcs/Ctn
43031001	0,5	6
43031002	1	6
43031003	2	6
43031004	3	4
43031006	5	4



» Ölçü Kabı
Measuring Cup

Kod Code	Lt Lt	Koli/Adet Pcs/Ctn
62010001	1	6
62010002	2	6



» Dörtlü Ölçek Seti
Measuring Cup Set

Kod Code	Koli/Adet Pcs/Ctn
40010058	6
*1/4 - 1/3 - 1/2 - 1/1 Cup	



» Dörtlü Ölçü Kaşık Seti
Measuring Spoon Set

Kod Code	Koli/Adet Pcs/Ctn
40010059	6
*2,5 cc - 5 cc - 7,5 cc - 15 cc	



» Pasta Standı
Cake Stand

Kod Code	Øxh (cm) Øxh (cm)	Koli/Adet Pcs/Ctn
32502005	20x5	2
32502205	22x5	2
32502405	24x5	2
32503005	30x5	2
32503605	36x5	2
32502210	22x10	2
32502410	24x10	2
32503010	30x10	2
32503610	36x10	2



» Döner Stand Paslanmaz Çelik
Revolving Cake Stand (S/S)

Kod Code	Øxh (cm) Øxh (cm)	Koli/Adet Pcs/Ctn
43031005	33	1



» Döner Stand
Revolving Cake Stand

Kod Code	Øxh (cm) Øxh (cm)	Koli/Adet Pcs/Ctn
43030074	33	1



» Alüminyum Baklava Tepsileri
Aluminum Confectionary Trays

Kod Code	Ölçü (cm) Dim. (cm)	Koli/Ad. Pcs/Ctn
43013040	30x40x4	6
43013345	33x45x4	6
43013545	35x45x4	6
43013547	35x47x4	6
43013851	38x51x4	4
43014050	40x50x4	4
43014060	40x60x4	4
43014061	40x60x1,5	4
43014062	40x60x2	4
43013480	34x80x2	4
43013484	34x84x2	4
43013488	34x88x2	4
43013080	30x80x5	2
43023488	34x88x5	2



» Kırılmaz Tepsisi
Cake stand

Kod Code	Ölçü (cm) Dim. (cm)	Koli/Ad. Pcs/Ctn
43030030	10x30	100
43031530	15x30	50
43032030	20x30	50
43032540	25x40	50

430	431	432	433
Şeffaf	Beyaz	Siyah	Kırmızı
Transparent	White	Black	Red

» Pasta / Kek Fanusu
Cake stand

Kod Code	Ölçü (cm) Dim. (cm)	Model Model	Koli/Adet Pcs/Ctn
80010005	30,5x30,5x11,5	Yuvarlak Round	1
80010007	39x16,5x12,5	Baton Rectangular	1



» Yanmaz Spatula

Heat-Resistant Spatula

Kod Code	Ölçü (cm) Dim. (cm)	Koli/Adet Pcs/Ctn
77503025	25	6
77503030	30	6
77503035	35	4
77503040	40	4
77503045	45	2
77503050	50	2



» Yanmaz Spatula

Heat-Resistant Spatula

Kod Code	Ölçü (cm) Dim. (cm)	Koli/Adet Pcs/Ctn
62012500	25	4
62013500	35	4
62014500	40	4



» Pizza Ruleti

Pizza Roulette

Kod Code	Ölçü (cm) Dim. (cm)	Koli/Adet Pcs/Ctn
62010021	10	6



» Pasta Spatula

Pastry Spatula

Kod Code	Ölçü (cm) Dim. (cm)	Koli/Adet Pcs/Ctn
62013025	25	4
62013030	30	4
62013035	35	2



» Belli Pasta Spatula

Angular Spatula

Kod Code	Ölçü (cm) Dim. (cm)	Koli/Adet Pcs/Ctn
62010025	25	4



» Spatula

Spatula

Kod Code	Ölçü (cm) Dim. (cm)	Koli/Adet Pcs/Ctn
62010010	10	4
62010013	13	4
62010015	15	4



» Geniş Spatula

Wide Spatula

Kod Code	Ölçü (cm) Dim. (cm)	Koli/Adet Pcs/Ctn
62012020	20	4
62011025	25	4



» Geniş Spatula Delikli

Perforated Wide Spatula

Kod Code	Ölçü (cm) Dim. (cm)	Koli/Adet Pcs/Ctn
62012025	25	4



» Pizza Küreği

Pizza Spatula

Kod Code	Ölçü (cm) Dim. (cm)	Model Model	Koli/Adet Pcs/Ctn
62010008	17	Normal Plain	4
62010014	17	Delikli Perforated	4



» Hamur Kazıyıcısı (Paslanmaz Saplı)
Dough Scraper (S/S Handle)

Kod Code	Ölçü (cm) Dim. (cm)	Koli/Adet Pcs/Ctn
62010006	13x11	6



» Hamur Kazıyıcısı (Plastik)
Dough Scraper (Plastic)

Kod Code	Ölçü (cm) Dim. (cm)	Koli/Adet Pcs/Ctn
62110006	15,5x9	6

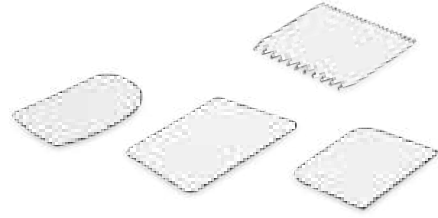

» Hamur Kazıyıcı 4'lü Set (Plastik)
Dough Scraper 4 pcs Set (Plastic)

Kod Code	Ölçü (cm) Dim. (cm)	Koli/Adet Pcs/Ctn
62110006	15,5x9	6



» Pasta Paleti (Paslanmaz Saplı)
Pastry Spatula (S/S Handle)

Kod Code	Ölçü (cm) Dim. (cm)	Koli/Adet Pcs/Ctn
44020101	20x3,5	6
44020102	25x3,5	6
44020103	30x3,5	6



» Pasta Bıçağı (Paslanmaz Saplı)
Pastry Knife (S/S Handle)

Kod Code	Ölçü (cm) Dim. (cm)	Koli/Adet Pcs/Ctn
44020201	20x3,5	6
44020202	25x3,5	6
44020203	30x3,5	6



» Dişli Pasta Bıçağı (Paslanmaz Saplı)
Pastry Knife (S/S Handle)

Kod Code	Ölçü (cm) Dim. (cm)	Koli/Adet Pcs/Ctn
44020301	20x3,5	6
44020302	25x3,5	6
44020303	30x3,4	6



» Pizza Küreği (Paslanmaz Saplı)
Pizza Spatula (S/S Handle)

Kod Code	Ölçü (cm) Dim. (cm)	Koli/Adet Pcs/Ctn
44020006	16x4x13,5	



» Servis Spatula (Paslanmaz)
Serving Spatula (S/S)

Kod Code	Ölçü (cm) Dim. (cm)	Koli/Adet Pcs/Ctn
62010011	25	6



» Spatula (Paslanmaz Saplı)
Spatula (S/S Handle)

Kod Code	Ölçü (cm) Dim. (cm)	Koli/Adet Pcs/Ctn
44020001	6,5x11	6
44020002	8x12	6
44020003	10x13,5	6
44020004	11x16	6
44020005	13x17	6





Servis/Serving



» Ecoform Tepsi
Ecoform Rectangular Tray

Kod Code	Ölçü (cm) Dim. (cm)	Koli/Adet Pcs/Ctn
68313753	37x53	5



» Maun Dikdörtgen Tepsi
Wooden Rectangular Tray

Kod Code	Ölçü (cm) Dim. (cm)	Koli/Adet Pcs/Ctn
68012738	27x38	5
68013244	32x44	5
68013646	36x46	5
68013753	37x53	5
68014361	43x61	5



» Kırçılı Tepsi
Textured Tray

plast|port®
by KAPP

Kod Code	Ölçü (cm) Dim. (cm)	Koli/Adet Pcs/Ctn
46612736	27x36	20
46613244	32x44	20
46613646	36x46	20
46613748	37x48	20
46613753	37x53	20



» Fiber Kaydırmaz Yuvarlak Tepsi
Fiber Non-slip Round Tray

Kod Code	Ø (cm) Ø (cm)	Koli/Adet Pcs/Ctn
68210035	35,5	5
68210040	40,6	5
68210045	45	5



» Maun Kaydırmaz Yuvarlak Tepsi
Wooden Non-slip Round Tray

Kod Code	Ø (cm) Ø (cm)	Koli/Adet Pcs/Ctn
68110033	33	10
68110038	38	10
68110043	43	10

» Maun Yuvarlak Tepsi
Wooden Round Tray

Kod Code	Ø (cm) Ø (cm)	Koli/Adet Pcs/Ctn
68010033	33	10
68010038	38	5
68010043	43	5



» Fiber Kaydırmaz Dikdörtgen Tepsi
Fiber Non-slip Rectangular Tray

Kod Code	Ölçü (cm) Dim. (cm)	Koli/Adet Pcs/Ctn
68213040	30x40	5
68213753	37x53	5
68214565	45x65	5
68215668	56x68	5



» Maun Kaydırmaz Dikdörtgen Tepsi
Wooden Non-slip Rectangular Tray

Kod Code	Ölçü (cm) Dim. (cm)	Koli/Adet Pcs/Ctn
68112738	27x38	10
68113244	32x44	25
68113646	36x46	10
68113753	37x53	10
68114361	43x61	15



» Ecoform Kaydırmaz Tepsi
Ecoform Non-slip Rectangular Tray

Kod Code	Ölçü (cm) Dim. (cm)	Koli/Adet Pcs/Ctn
68413753	37x53	5



» Servis Tepsisi (ABS)
Serving Tray (ABS)

Kod Code	Ölçü (cm) Dim. (cm)	Koli/Adet Pcs/Ctn
46012736	27x36	20
46013244	32x44	20
46013646	36x46	20
46013748	37x48	20
46013753	37x53	20



» Servis Tepsisi (ABS)
Serving Tray (ABS)

Kod Code	Ölçü (cm) Dim. (cm)	Koli/Adet Pcs/Ctn
46112736	27x36	20
46113244	32x44	20
46113646	36x46	20
46113748	37x48	20
46113753	37x53	20



» Servis Tepsisi (ABS)
Serving Tray (ABS)

Kod Code	Ölçü (cm) Dim. (cm)	Koli/Adet Pcs/Ctn
46212736	27x36	20
46213244	32x44	20
46213646	36x46	20
46213748	37x48	20
46213753	37x53	20



» Servis Tepsisi (ABS)
Serving Tray (ABS)

Kod Code	Ölçü (cm) Dim. (cm)	Koli/Adet Pcs/Ctn
46312736	27x36	20
46313244	32x44	20
46313646	36x46	20
46313748	37x48	20
46313753	37x53	20



» Servis Tepsisi (ABS)
Serving Tray (ABS)

Kod Code	Ölçü (cm) Dim. (cm)	Koli/Adet Pcs/Ctn
46412736	27x36	20
46413244	32x44	20
46413646	36x46	20
46413748	37x48	20
46413753	37x53	20



» Servis Tepsisi (ABS)
Serving Tray (ABS)

Kod Code	Ölçü (cm) Dim. (cm)	Koli/Adet Pcs/Ctn
46512736	27x36	20
46513244	32x44	20
46513646	36x46	20
46513748	37x48	20
46513753	37x53	20

Tepsiler / Trays



» 1/1 GN Tepsi 1/1 GN Tray

Kod Code	Ölçü (mm) Dim. (mm)	It lt	Koli/Adet Pcs/Ctn
31611010	530x325x10	1,25	6
31611020	530x325x20	2,5	6
31611040	530x326x40	5	6

» 2/3 GN Tepsi 2/3 GN Tray

Kod Code	Ölçü (mm) Dim. (mm)	It lt	Koli/Adet Pcs/Ctn
31623010	354x325x10	0,75	6
31623020	354x325x20	1,5	6
31623040	354x325x40	3	6

» 1/2 GN Tepsi 1/2 GN Tray

Kod Code	Ölçü (mm) Dim. (mm)	It lt	Koli/Adet Pcs/Ctn
31612010	325x265x10	0,5	6
31612020	325x265x20	1,25	6
31612040	325x265x40	2,5	6



» Banket Tepsi Kenar Desenli Figured Tray for Open Buffet

Kod Code	Ölçü (mm) Dim. (mm)	Koli/Adet Pcs/Ctn
31611005	530x325	6

» Self Servis Standard Self Service

Kod Code	Ölçü (mm) Dim. (mm)	Kalınlık Thickness	Koli/Adet Pcs/Ctn
35040050	28x40x2,5	0,50 mm	25
35040060	28x40x2,5	0,60 mm	25
35040070	28x40x2,5	0,70 mm	25
35040080	28x40x2,5	0,80 mm	25
35040100	28x40x2,5	1,00 mm	25

» Bölmeli Self Servis Partitioned Self Service

Kod Code	Ölçü (cm) Dim. (cm)	Model Model	Koli/Adet Pcs/Ctn
35820003	12x25,5x1,5 Ø 23x2	3 Bölmeli 3 Partition	25
35820004		5 Bölmeli 5 Partition	25



» Standart Self Servis PC **plast|port®** Standart Self Service PC

Kod Code	Ölçü (mm) Dim. (mm)	Model Model	Koli/Adet Pcs/Ctn
46010111	398x278x28	Standard	20
46010118	398x278x28	ABS	20

» Self Servis PC Kriş **plast|port®** Self Service PC For Kids

Kod Code	Ölçü (mm) Dim. (mm)	Koli/Adet Pcs/Ctn
46010112	360x245x26	20

» Kahvaltılık Self Servis PC **plast|port®** Self Service for Breakfast PC

Kod Code	Ölçü (mm) Dim. (mm)	Model Model	Koli/Adet Pcs/Ctn
46010113	290x180x18	Kahvaltılık Breakfast	20
46010114	290x180x18	Yumurtalıklı w/Egg Part	20
46010115	400x280x30	Hindistan Indian	20



» Kaynaklı Kepece
Ladle

Kod Code	Ø (cm) Ø (cm)	Kapasite(gr) Capacity (gr)	Koli/Adet Pcs/Ctn
31500001	7,8	75	6
31500002	8,8	100	6
31500003	9,5	145	6
31500004	10,7	220	6
31500005	13,2	456	6
31500016	15,5	661	6
31500007	18	975	6
31500008	20,7	1398	3
31500009	22,5	2150	3
31500010	25	3050	3

» Monoblok Kepece
Monoblock Ladle

Kod Code	Ø (cm) Ø (cm)	Kapasite(gr) Capacity (gr)	Koli/Adet Pcs/Ctn
31500065	6,5	63	6
31500080	8	125	6
31500090	9	200	6
31500100	10	250	6
31500120	12	500	6
31500140	14	750	6
31500160	16	1000	6
31500180	18	1250	6
31500200	20	2050	6

» Sos Kepeçesi
Sauce Ladle

Kod Code	Ø (cm) Ø (cm)	Kapasite(gr) Capacity (gr)	Koli/Adet Pcs/Ctn
31503017	5,5	67,5	6
31503018	6,5	70	6
31503019	7	72,5	6
31503020	7,8	75	6

* Ø 15,5 cm ve üzeri kepeçer desteklidir.
* Ø 15,5 cm and above are reinforced

113



» Kaynaklı Kevgir
Skimmer

Kod Code	Ø (cm) Ø (cm)	Koli/Adet Pcs/Ctn
31600001	9,3	6
31600002	10,4	6
31600003	11,3	6
31600004	12,9	6
31600005	15,1	6
31600016	17,4	6
31600007	19,7	6
31600008	22,2	3
31600009	25,1	3
31600010	28	3

» Monoblok Kevgir
Monoblock Skimmer

Kod Code	Ø (cm) Ø (cm)	Koli/Adet Pcs/Ctn
31600080	8	6
31600100	10	6
31600120	12	6
31600140	14	6
31600160	16	6
31600180	18	6
31600200	20	6

» Pilav Servis (Kaynaklı)
Service Spoon

Kod Code	Ø (cm) Ø (cm)	Koli/Adet Pcs/Ctn
31600021	9,3	6
31600022	10,4	6
31600023	11,3	6
31600024	12,9	6
31600025	15,1	6
31600026	17,4	6

* Ø 15,1 cm ve üzeri kepeçer desteklidir.
* Ø 15,1 cm and above are reinforced





» Monoblok Düz Kaşık
Monoblock Spoon

Kod Code	Uzunluk (cm) L (cm)	Koli/Adet Pcs/Ctn
31601106	27	6
31600104	38	6
31601104	43	6



» Monoblok Süzgeçli Kaşık
Monoblock Perforated Spoon

Kod Code	Uzunluk (cm) L (cm)	Koli/Adet Pcs/Ctn
31601107	27	6
31600105	38	6
31601105	43	6



» Düz Servis Kaşık
Serving Spoon

Kod Code	Uzunluk (cm) L (cm)	Koli/Adet Pcs/Ctn
90000009	21	6
90000006	30	6
90000005	43	6



» Süzgeçli Servis Kaşık
Perforated Serving Spoon

Kod Code	Uzunluk (cm) L (cm)	Koli/Adet Pcs/Ctn
90000010	21	6
90000008	30	6
90000004	43	6



» Et Çatalı (Monoblok)
Monoblock Meat Fork

Kod Code	Uzunluk (cm) L (cm)	Model Model	Koli/Adet Pcs/Ctn
31602104	50	İkili/2 Prongs	6
31601002	70	İkili/2 Prongs	6
31601003	50	Üçlü/3 Prongs	6
31601004	70	Üçlü/3 Prongs	6



» Servis Çatalı
Meat Fork for Serving

Kod Code	Uzunluk (cm) L (cm)	Koli/Adet Pcs/Ctn
90000011	21	6
90000007	30	6



» Monoblok Servis Spatula
Monoblock Spatula

Kod Code	Uzunluk (cm) L (cm)	Koli/Adet Pcs/Ctn
52020021	21	6
52020030	30	6
52020036	36	6



» Monoblok Süzgeçli Servis Spatula
Monoblock Perforated Spatula

Kod Code	Uzunluk (cm) L (cm)	Koli/Adet Pcs/Ctn
52021021	21	6
52021030	30	6
52021036	36	6



» Servis Spatula
Serving Spatula

Kod Code	Uzunluk (cm) L (cm)	Koli/Adet Pcs/Ctn
90000015	21	6
90000012	30	6



» Süzgeçli Servis Spatula
Perforated Serving Spatula

Kod Code	Uzunluk (cm) L (cm)	Koli/Adet Pcs/Ctn
90000014	21	6
90000013	30	6



» Delikli Servis Kasık
Perforated Spoon

Kod Code	Ölçü (mm) Dim. (mm)	Koli/Adet Pcs/Ctn
52010046	275x53	6



» Servis Kasığı
Serving Spoon

Kod Code	Ölçü (mm) Dim. (mm)	Koli/Adet Pcs/Ctn
52010045	275x62	6



» Spagetti Kasığı
Spaghetti Spoon

Kod Code	Ölçü (mm) Dim. (mm)	Koli/Adet Pcs/Ctn
52010058	270x65	6



» Kevgir
Skimmer

Kod Code	Ölçü (mm) Dim. (mm)	Koli/Adet Pcs/Ctn
52010042	270x80	6



» Delikli Spatula
Perforated Turner

Kod Code	Ölçü (mm) Dim. (mm)	Koli/Adet Pcs/Ctn
52010044	285x75	6



» Çorba Kepçesi
Ladle

Kod Code	Ölçü (mm) Dim. (mm)	Koli/Adet Pcs/Ctn
52010041	245x60	6



» Delikli Kek Servis
Perforated Spatula

Kod Code	Ölçü (mm) Dim. (mm)	Koli/Adet Pcs/Ctn
52010049	315x63	6



» PC Servis Kaşığı **plast|port**
PC Serving Spoon by KAPP

Kod Code	Koli/Adet Pcs/Ctn
46010007	50



» PC Delikli Servis Kaşığı **plast|port**
PC Perforated Serving Spoon by KAPP

Kod Code	Koli/Adet Pcs/Ctn
46010008	50



» Silikon Kaşık
Silicone Spoon

Kod Code	Ölçü (mm) Dim. (mm)	Koli/Adet Pcs/Ctn
52030003	330x65	6

-40°C ~ +230°C



» PC Sos Keççe **plast|port**
PC Sauce Ladle by KAPP

Kod Code	Ölçü (cm) Dim. (cm)	Koli/Adet Pcs/Ctn
46010009	20	25
46010015	24	25



» PC Maşa **plast|port**
PC Tong by KAPP

Kod Code	Model Model	Koli/Adet Pcs/Ctn
46010018	Makarna Pasta	15
46010021	Servis Serving	15



» Spagetti Maşa
Pasta Tong

Kod Code	Ölçü (cm) Dim. (cm)	Koli/Adet Pcs/Ctn
36302000	22	6

117



» Çok Amaçlı Maşa
Multi-Purpose Tong

Kod Code	Ölçü (cm) Dim. (cm)	Koli/Adet Pcs/Ctn
62010030	30	6
62010141	41	6



» Silikon Servis Maşa (Kilitli)
Silicone Serving Tong

Kod Code	Ölçü (cm) Dim. (cm)	Koli/Adet Pcs/Ctn
40306021	30	6

-40°C ~ +230°C



» Silikon Saplı Servis Maşa
Serving Tong w/Silicone Handle

Kod Code	Ölçü (cm) Dim. (cm)	Koli/Adet Pcs/Ctn
40306020	22	6



» Makaslı Maşa
Salad Tong

Kod Code	Ölçü (cm) Dim. (cm)	Koli/Adet Pcs/Ctn
52010181	25	6



» Makaslı Maşa
Serving Tong

Kod Code	Ölçü (cm) Dim. (cm)	Koli/Adet Pcs/Ctn
52010189	25	6



» Makaslı Maşa
Bread/Pastry Tong

Kod Code	Ölçü (cm) Dim. (cm)	Koli/Adet Pcs/Ctn
52010187	25	6



» Çok Amaçlı Maşa
Multi-Purpose Tong

Kod Code	Ölçü (cm) Dim. (cm)	Koli/Adet Pcs/Ctn
52010710	25	6

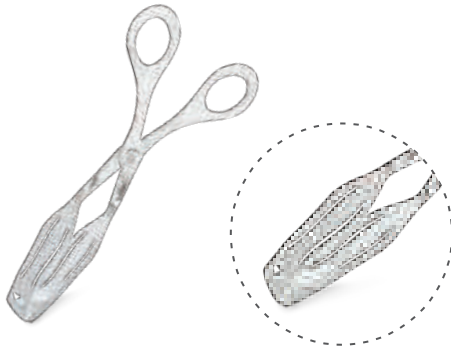

» Makaslı Maşa Küçük
Bread/Pastry Tong Small

Kod Code	Ölçü (cm) Dim. (cm)	Koli/Adet Pcs/Ctn
52020003	19,5	6



» Makaslı Maşa Küçük
Salad Tong Small

Kod Code	Ölçü (cm) Dim. (cm)	Koli/Adet Pcs/Ctn
52020005	19,5	6



» Şef Cımbızı
Chef's Tong

Kod Code	Ölçü (mm) Dim. (mm)	Model Model	Koli/Adet Pcs/Ctn
77502913	145x10	Düz/Straight	6
77502021	180x25	Belli/Angular	6
77500025	250	Düz/Straight	6

» Salata Maşa
Salad Tong

Kod Code	Ölçü (cm) Dim. (cm)	Koli/Adet Pcs/Ctn
36310000	22	6

» Pasta Maşa
Pastry Tong

Kod Code	Ölçü (cm) Dim. (cm)	Koli/Adet Pcs/Ctn
36311000	21,5	6



» Buz Maşa
Ice Tong

Kod Code	Ölçü (cm) Dim. (cm)	Model Model	Koli/Adet Pcs/Ctn
36303000	16	Classic/Klasik	6
52020004	19	Lüks/Lux	6

» Şeker Maşa
Sugar Tong

Kod Code	Ölçü (cm) Dim. (cm)	Koli/Adet Pcs/Ctn
36304000	23	1

» Kılıçık Temizleme Maşası
Fish Bone Pincer

Kod Code	Ölçü (cm) Dim. (cm)	Koli/Adet Pcs/Ctn
40306022	12	6



» Izgara Maşa
Grill Tong

Kod Code	Ölçü (cm) Dim. (cm)	Koli/Adet Pcs/Ctn
36306001	25	6
36306002	27,5	6
36306003	32,5	6
36306004	40	6

» Kömür Maşa
Charcoal Tong

Kod Code	Ölçü (cm) Dim. (cm)	Koli/Adet Pcs/Ctn
36306011	25	6
36306012	27,5	6
36306013	32,5	6
36306014	40	6



» Dekor Kaşık
Deco Spoon

Kod Code	Ø (mm) Ø (mm)	h (mm) h (mm)	Koli/Adet Pcs/Ctn
77506436	75	55	1



» Kaşık Standı
Spoon Rest

Kod Code	Koli/Adet Pcs/Ctn
52010183	6



» Kepçe/Kaşık Standı
Spoon/Ladle Rest

Kod Code	Ölçü (cm) Dim. (cm)	Koli/Adet Pcs/Ctn
62010009	9x17	6

* Fiyata kepçe dahil değildir.
* Ladle is not included



» Dondurma/Ordövr Makası
Ice Cream Spoon

Kod Code	Ø (mm) Ø (mm)	Koli/Adet Pcs/Ctn
52019039	39	6
52019044	44	6
52019050	50	6
52019056	56	6
52019063	63	6



» Dondurma Kaşığı
Ice Cream Spoon

Kod Code	Koli/Adet Pcs/Ctn
62010037	6



» Pilav Ölçeği
Rice Scoop

Kod Code	Ø (mm) Ø (mm)	No No	Koli/Adet Pcs/Ctn
39330001	8	1	6
39330002	8,5	2	6
39330003	9,5	3	6
39330004	10,5	4	6
39330005	13,5	5	6



» Patates Küreği
French Fries Shovel

Kod Code	Ölçü (cm) Dim. (cm)	Koli/Adet Pcs/Ctn
62010000	20	2



» Ketchup Dispenseri **plast|port®**
Ketchup Dispenser

Kod Code	Lt Lt	Koli/Adet Pcs/Ctn
46010022	2	1



» Mayonez Dispenseri **plast|port®**
Mayonnaise Dispenser

Kod Code	Lt Lt	Koli/Adet Pcs/Ctn
46010023	2	1



» Hardal Dispenseri **plast|port®**
Mustard Dispenser

Kod Code	Lt Lt	Koli/Adet Pcs/Ctn
46010025	2	1



» Ketchup Şişesi
Ketchup Bottle

Kod Code	ml ml	Koli/Adet Pcs/Ctn
43030250	250	6
43030500	500	6
43030750	750	6



» Mayonez Şişesi
Mayonnaise Bottle

Kod Code	ml ml	Koli/Adet Pcs/Ctn
43031250	250	6
43031500	500	6
43031750	750	6



» Hardal Şişesi
Mustard Bottle

Kod Code	ml ml	Koli/Adet Pcs/Ctn
43032250	250	6
43032500	500	6
43032750	750	6



» Şeffaf Sos Şişesi
Transparent Sauce Bottle

Kod Code	ml ml	Koli/Adet Pcs/Ctn
43033250	250	6
43033500	500	6
43033750	750	6



» Sos/Surup Dökücü
Pouring Container

Kod Code	ml ml	Koli/Adet Pcs/Ctn
60020001	1	4
60020002	2	4





Açık Büfe/Open Buffet

VEGA CHAFING DISH

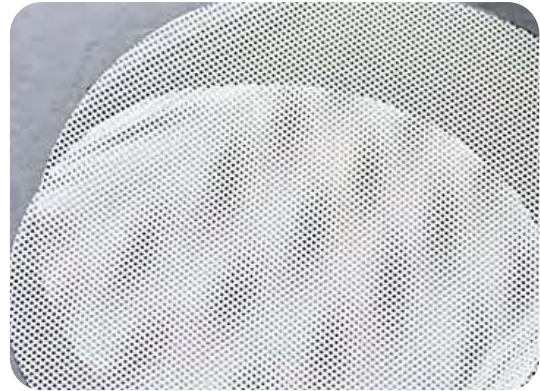

124

- 1 Kendinden 500 W Elektrikli Isıtıcı
Self Electrical Heating 500 W
- 2 Su Geçirmez Kontrol
Waterproof Switch
- 3 90° de sabitlenebilir kapak
Stable at 90°
- 4 Çıkarılabilir Elektrik Kablosu
Removable power cord
- 5 Silikon Koruyucu
Silicone Protector Pad

Çıkarılabilir Kapak
Removable Cover

Geniş Cam Kapak
Full Glass Window

Hidrolik Kapak
Hydraulic Lid



NEW



54010101

İndüksiyon ocaklara uygundur
Suitable for Induction Plates

126

Kod Code	Model Model	Ölçü (cm) Dim. (cm)
56012011	GN 1/1 - 9 lt.	63x46x17
54010101	İndüksiyon Isıtıcı 1000W/220V Induction Heating 1000W/220V	

Kendinden 500 W Elektrikli Isıtıcı
Self Electrical Heating System 500 W



Hidrolik Kapak
Hydraulic Lid



Su Geçirmez Kontrol
Waterproof Switch



Çıkarılabilir Elektrik Kablosu
Removable power cord



Hidrolik Kapak
Hydraulic Lid



NEW



54010101

İndüksiyon ocaklara uygundur
Suitable for Induction Plates

Kod Code	Model Model	Ölçü (cm) Dim. (cm)
56012032	GN 2/3 - 6 lt.	48x46x17
54010101	İndüksiyon Isıtıcı 1000W/220V Induction Heating 1000W/220V	

127

Kendinden 500 W Elektrikli Isıtıcı
Self Electrical Heating System 500 W



Hidrolik Kapak
Hydraulic Lid

Su Geçirmez Kontrol
Waterproof Switch



Çıkarılabilir Elektrik Kablosu
Removable power cord



Hidrolik Kapak
Hydraulic Lid



NEW



54010101

İndüksiyon ocaklara uygundur
Suitable for Induction Plates



128

» Kod Code	Model Model	Ölçü (cm) Dim. (cm)
56012060	Yuvarlak - 6 lt. / Round - 6lt	50x50x17
54010101	İndüksiyon Isıtıcı 1000W/220V Induction Heating 1000W/220V	

Kendinden 500 W Elektrikli Isıtıcı
Self Electrical Heating System 500 W



Su Geçirmez Kontrol
Waterproof Switch



Çıkarılabilir Elektrik Kablosu
Removable power cord



Hidrolik Kapak
Hydraulic Lid



NEW



54010101

İndüksiyon ocaklara uygundur
Suitable for Induction Plates

Kod Code	Model Model	Ölçü (cm) Dim. (cm)
56012015	Çorbalık - 11 lt. / Soup Station- 11lt	40x40x28,5
54010101	İndüksiyon Isıtıcı 1000W/220V Induction Heating 1000W/220V	

Kendinden 500 W Elektrikli Isıtıcı
Self Electrical Heating System 500 W



Su Geçirmez Kontrol
Waterproof Switch



Çıkarılabilir Elektrik Kablosu
Removable power cord



Hidrolik Kapak
Hydraulic Lid



Hidrolik Kapak
Hydraulic Lid



CARINA CHAFING DISH



90 ° de Sabitlenebilir Kapak

Kapak yavaşça ve sessizce otomatik olarak kapanır
Çıkarılabilir kapak kolay temizlik ve depolama sağlar

Open up to 90 °

Lid falls and closed automatically silently

Removable cover: easy for cleaning and storage

Buhar Toplama Sistemi
Buhardan oluşan su damlaları
su kabına geri akar yemeğin
üzerine akmaz

*Water Return System
Condensation flows back to
water pan instead of food*

Patentli Hidrolik Mentеше
Min. 100.000 açma-kapama

*Patented Hydraulic Hinge
Min. 100.000 times open-close*

3 Kat Çelik Taban
Hızlı ve eşit pişirme için

*Three-layer Steel Bottom
for fast and even heating*

NEW

Hidrolik Kapak
Hydraulic Lid



55012011

55013011



132

54010101

İndüksiyon ocaklara uygundur
Suitable for Induction Plates



54010500

9 Kademeli 500 W Termostatlı Isıtıcı ile uyumludur
Suitable for 500 W Electrical Heating Unit w/9 Temperature Control

>> Kod Code	Model Model	Ölçü (cm) Dim. (cm)
55012011	GN 1/1 - 11,2 lt.	58x47,5x17
55013011	GN 1/1 Ayaklı Stand/ Stand	61,5x40x17,5
54010101	İndüksiyon Isıtıcı 1000W/220V Induction Heating 1000W/220V	



55013011



55012011

NEW

Hidrolik Kapak
Hydraulic Lid



54010101

İndüksiyon ocaklara uygundur
Suitable for Induction Plates



55012032

55012035

133



54010500

9 Kademeli 500 W Termostatlı Isıtıcı ile uyumludur
Suitable for 500 W Electrical Heating Unit w/9 Temperature Control

>> Kod Code	Model Model	Ölçü (cm) Dim. (cm)
55012032	GN 2/3 - 5,5 lt.	47,5x41x17
55012035	GN 2/3 Ayaklı Stand/ Stand	43,5x40x17,5
54010101	İndüksiyon Isıtıcı 1000W/220V Induction Heating 1000W/220V	



55012035



55012032

NEW

Hidrolik Kapak
Hydraulic Lid



55012060



54010101

İndüksiyon ocaklara uygundur
Suitable for Induction Plates

134

55012065



54010500

9 Kademeli 500 W Termostatlı Isıtıcı ile uyumludur
Suitable for 500 W Electrical Heating Unit w/9 Temperature Control

Kod Code	Model Model	Ölçü (cm) Dim. (cm)
55012060	Yuvarlak 5,7 Lt. / Round 5,7 Lt	53,5x45,5x17
55012065	Yuvarlak Ayaklı Stand / Round Stand	44,5x44,5x17,5
54010101	İndüksiyon Isıtıcı 1000W/220V Induction Heating 1000W/220V	



55012065



55012060

NEW

Hidrolik Kapak
Hydraulic Lid

55012015



54010101

İndüksiyon ocaklara uygundur
Suitable for Induction Plates

55012018

135



54010500

9 Kademeli 500 W Termostatlı Isıtıcı ile uyumludur
Suitable for 500 W Electrical Heating Unit w/9 Temperature Control

Kod Code	Model Model	Ölçü (cm) Dim. (cm)
55012015	Çorbalık 14,3 Lt./ Soup Station 14,3 Lt.	47,5x43,5x26,5
55012018	Çorbalık Ayaklı Stand/ Soup Station Stand	37x37x17,5
54010101	İndüksiyon Isıtıcı 1000W/220V Induction Heating 1000W/220V	



55012018



55012015



Kendinden Buz Hazneli Kapak
Lid has Self Ice Store



» Carina İçecek Dispenseri
Carina Juice Dispenser

Kod Code	Lt Lt
55011277	7,7
55011278	2x7,7
55011279	3x7,7



» Carina Süt Dispenseri
Carina Milk Dispenser

Kod Code	Lt Lt
55011212	6,4



» Vega Kahve Dispenseri
Vega Coffee Dispenser

Kod	Lt
Code	Lt
55011312	12



» Vega İçecek Dispenseri
Vega Juice Dispenser

Kod	Lt
Code	Lt
55011412	12

137



» Carina Corn Flakes Dispenseri
Carina Sereal Dispenser

Kod	Lt
Code	Lt
55011231	3,7



» Carina Corn Flakes Dispenseri
Carina Sereal Dispenser

Kod	Lt
Code	Lt
55011232	2x3,7



» Carina Corn Flakes Dispenseri
Carina Sereal Dispenser

Kod	Lt
Code	Lt
55011233	3x3,7

Premium Chafing Dish



Hidrolik Kapak
Hydraulic Lid



54011011



54011011

İndüksiyon ocaklara uygundur
Suitable for Induction Plates

Kod Code	Model Model	Ölçü (cm) Dim. (cm)	Koli/Adet Pcs/Ctn
54011011	GN 1/1 - 9 lt.	59,5x46x23,5	1
54011014	GN 1/1 Ayaklı Stand/ Stand	52x42x17,5	1
54010101	İndüksiyon Isıtıcı 1000W/220V Induction Heating 1000W/220V		1

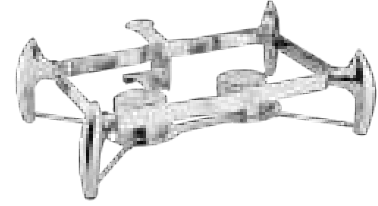

54011014



54010101

139

Hidrolik Kapak
Hydraulic Lid



54011032



54011032

İndüksiyon ocaklara uygundur
Suitable for Induction Plates

Kod Code	Model Model	Ölçü (cm) Dim. (cm)	Koli/Adet Pcs/Ctn
54011032	GN 2/3 - 6 lt.	46x42x22,5	1
54011035	GN 2/3 Ayaklı Stand/ Stand	42x38x21,8	1
54010101	İndüksiyon Isıtıcı 1000W/220V Induction Heating 1000W/220V		1



54011035



54010101

Premium Chafing Dish

Hidrolik Kapak
Hydraulic Lid



54011060

54011160



54011060

İndüksiyon ocaklara uygundur
Suitable for Induction Plates

Kod Code	Model Model	Ölçü (cm) Dim. (cm)	Koli/Adet Pcs/Ctn
54011060	Yuvarlak 6 Lt. / Round 6 Lt	52,5x46x22,5	1
54011160	Yuvarlak Ayaklı Stand / Round Stand	43,5x33x18	1
54010101	İndüksiyon Isıtıcı 1000W/220V Induction Heating 1000W/220V		1



54010101



54011160

140

Hidrolik Kapak
Hydraulic Lid



54011015

54011018



54011015

İndüksiyon ocaklara uygundur
Suitable for Induction Plates

Kod Code	Model Model	Ölçü (cm) Dim. (cm)	Koli/Adet Pcs/Ctn
54011015	Çorbalık 11 Lt. / Soup Station 11 Lt.	44x44x33	1
54011018	Çorbalık Ayaklı Stand / Soup Station Stand	43,5x33x18	1
54010101	İndüksiyon Isıtıcı 1000W/220V Induction Heating 1000W/220V		1



54010101



54011018



» Premium Süt Dispenseri
Premium Milk Dispenser

Kod Code	(Lt) (Lt)	Koli/Adet Pcs/Ctn
54011212	6	1



» Premium İçecek Dispenseri
Premium Juice Dispenser

Kod Code	(Lt) (Lt)	Koli/Adet Pcs/Ctn
54011112	12	1



» Premium Kahve Dispenseri
Premium Coffee Dispenser

Kod Code	(Lt) (Lt)	Koli/Adet Pcs/Ctn
59011019	19	1



» Gömme İndüksiyon ocak
Built-In Induction Cooker

Kod Code	Güç Power	Koli/Adet Pcs/Ctn
57103838	3500 W	1



» 1/1 İndüksiyon Chafing Dish Standı
1/1 Stand w/Warmer

Kod Code	Koli/Adet Pcs/Ctn
54014011	1

* İndüksiyon ocaklar fiyata dahildir. * Induction cookers included

Delux Chafing Dish Genel Özellikler

Delux Chafing Dish Specifications



142

- 1 90° de sabitlenebilir kapak
Stable at 90°
- 2 180° açılır kapak
Stable at 180°
- 3 Kolay çıkarılabilir, yıkanabilir kapak
For quick and easy cleaning
- 4 9 kademeli termostatlı ısıtıcı
Electrical heating unit w/9 Temperature Control
- 5 5 Üst üste muhafaza edilebilme özelliği
Stackable Design



» GN 1/1 Roll Top
GN 1/1 Roll Top

Kod Code	Model Model	Ölçü (cm) Dim. (cm)
54010733	9 lt. Jelli/ w/Burner	73x49x34
54010500	Termostatlı Isıtıcı 500 W/ Electrical Heater 500 W	



» Yuvarlak Roll Top
Round Roll Top

Kod Code	Model Model	Ölçü (cm) Dim. (cm)
54010731	6 lt. Jelli/w/Burner	53x53x35
54010500	Termostatlı Isıtıcı 500 W/ Electrical Heater 500 W	



ÖZELLİKLER

- 90° de sabitlenebilir kapak
- 180° açılır kapak
- Kolay çıkarılabilir, yıkanabilir kapak
- 9 kademeli termostatlı ısıtıcı
- Üst üste muhafaza edilebilme özelliği

143



» Roll Top Çift Çorbalık
Roll Top w/Soup Tureens

Kod Code	Model Model	Ölçü (cm) Dim. (cm)
54010738	2x4,5 lt. Jelli/w/Burner	73x49x34
54010500	Termostatlı Isıtıcı 500 W/ Electrical Heater 500 W	



» Roll Top Çorbalık
Round Roll Top w/Soup Tureens

Kod Code	Model Model	Ölçü (cm) Dim. (cm)
54010730	6 lt. Jelli/w/Burner	53x53x35
54010500	Termostatlı Isıtıcı 500 W/ Electrical Heater 500 W	





» Gmme GN 1/1
Built-In GN 1/1

Kod Code	Model Model	l (cm) Dim. (cm)
54012733	9 lt. Jelli/ w/Burner	63x46,5x24
54010500	Termostatlı Isıtıcı 500 W/ Electrical Heater 500 W	

SPECIFICATIONS

- Stable at 90°
- Stable at 180°
- For quick & easy cleaning
- Electrical heating unit w/9 Temperature Control
- Stackable design

144



» Gmme Yuvarlak
Built-In Round Shaped

Kod Code	Model Model	l (cm) Dim. (cm)
54012731	6 lt. Jelli/w/Burner	63x48x26
54010500	Termostatlı Isıtıcı 500 W/ Electrical Heater 500 W	



» Gmme orbalk
Built-In Round Shaped w/Soup Tureen

Kod Code	Model Model	l (cm) Dim. (cm)
54012730	6 lt. Jelli/w/Burner	63x48x26
54010500	Termostatlı Isıtıcı 500 W/ Electrical Heater 500 W	



» GN 1/1 Roll Top
GN 1/1 Roll Top

Kod Code	Model Model	Ölçü (cm) Dim. (cm)
54010723	9 lt. Jelli/ w/Burner	75x50x33
54010500	Termostatlı Isıtıcı 500 W/ Electrical Heater 500 W	



» Yuvarlak Roll Top
Roll Top Round Shaped

Kod Code	Model Model	Ölçü (cm) Dim. (cm)
54010721	6 lt. Jelli/w/Burner	53x49,5x35
54010500	Termostatlı Isıtıcı 500 W/ Electrical Heater 500 W	



» Çorbalık Roll Top
Round Shaped w/Soup Tureen

Kod Code	Model Model	Ölçü (cm) Dim. (cm)
54010720	6 lt. Jelli/w/Burner	53x49,5x35
54010500	Termostatlı Isıtıcı 500 W/ Electrical Heater 500 W	

Chafing Dish / Chafing Dish



» Ekonomik GN 1/1
Economic GN 1/1

Kod Code	Model Model	Ölçü (cm) Dim. (cm)
54010433	9 lt. Jelli 9 lt. w/Burner	60x35x32



» Mini Chafing Dish
Mini Chafing Dish

Kod Code	Model Model	Ölçü (cm) Dim. (cm)
40210151	Jelli w/Burner	32x32

146



» 9 Kademeli Termostatlı Isıtıcı
Electrical Heating Unit w/9 Temperature Control

Kod Code	Güç Power	Koli/Adet Pcs/Ctn
54010800	700 Watt	1
54010500	500 Watt	1



» İndüksiyon Isıtıcı
Induction Heating

Kod Code	Güç Power	Koli/Adet Pcs/Ctn
54010101	1000 W	1



» Yakıt Haznesi
Burner Holder

Kod Code	Koli/Adet Pcs/Ctn
54010100	2



» İsimlik
Name Tag

Kod Code	h(cm) h(cm)	Koli/Adet Pcs/Ctn
62010005	5	12
62011010	10	12
62013020	20	12



» Kaşık Standı
Spoon Rest

Kod Code	Koli/Adet Pcs/Ctn
52010183	6



» Kepece Standı
Spoon/Ladle Rest

Kod Code	Ölçü (cm) Dim. (cm)	Koli/Adet Pcs/Ctn
62010009	9x17	6



» GN 1/1 Porselen
GN 1/1 Porcelain

Kod Code	l (mm) Dim. (mm)	Koli/Adet Pcs/Ctn
70020101	530x325	1



» GN 1/2 Porselen
GN 1/2 Porcelain

Kod Code	l (mm) Dim. (mm)	Koli/Adet Pcs/Ctn
70020102	325x265	1



» GN 2/3 Porselen
GN 2/3 Porcelain

Kod Code	l (mm) Dim. (mm)	Koli/Adet Pcs/Ctn
70020203	354x325	1



» GN 1/3 Porselen
GN 1/3 Porcelain

Kod Code	l (mm) Dim. (mm)	Koli/Adet Pcs/Ctn
70020103	325x176	1



» Yuvarlak Porselen
Round Porcelain

Kod Code	l (cm) Dim. (cm)	Koli/Adet Pcs/Ctn
70020100	39x6,5	1



» Yuvarlak Blmeli Porselen
Round Divided Porcelain

Kod Code	l (cm) Dim. (cm)	Koli/Adet Pcs/Ctn
70021100	39x6,5	1



» Yuvarlak Tepsi
Round Tray (S/S)

Kod Code	l (cm) Dim. (cm)	Lt Lt	Koli/Adet Pcs/Ctn
30703565	35x6,5	6,2	4



» Yuvarlak Blmeli Tepsi
Round Divided Tray (S/S)

Kod Code	l (cm) Dim. (cm)	Koli/Adet Pcs/Ctn
70023100	38,5x38,5x6,5	1



» Delikli Servis Kasık
Perforated Spoon

Kod Code	Ölçü (mm) Dim. (mm)	Koli/Adet Pcs/Ctn
52010046	275x53	6



» Servis Kasığı
Serving Spoon

Kod Code	Ölçü (mm) Dim. (mm)	Koli/Adet Pcs/Ctn
52010045	275x62	6



» Spagetti Kasığı
Spaghetti Spoon

Kod Code	Ölçü (mm) Dim. (mm)	Koli/Adet Pcs/Ctn
52010058	270x65	6



» Kevgir
Skimmer

Kod Code	Ölçü (mm) Dim. (mm)	Koli/Adet Pcs/Ctn
52010042	270x80	6



» Delikli Spatula
Perforated Turner

Kod Code	Ölçü (mm) Dim. (mm)	Koli/Adet Pcs/Ctn
52010044	285x75	6



» Çorba Kepçesi
Ladle

Kod Code	Ölçü (mm) Dim. (mm)	Koli/Adet Pcs/Ctn
52010041	245x60	6



» Delikli Kek Servis
Perforated Spatula

Kod Code	Ölçü (mm) Dim. (mm)	Koli/Adet Pcs/Ctn
52010049	315x63	6



» Vega İçecek Dispenseri
Vega Juice Dispenser

Kod Code	Lt Lt	Koli/Adet Pcs/Ctn
55011412	12	1



» Vega Kahve Dispenseri
Vega Coffee Dispenser

Kod Code	Lt Lt	Koli/Adet Pcs/Ctn
55011312	12	1



» Carina İçecek Dispenseri
Carina Juice Dispenser

Kod Code	Lt Lt	Koli/Adet Pcs/Ctn
55011277	7,7	1
55011278	2x7,7	1
55011279	3x7,7	1



» Carina Süt Dispenseri
Carina Milk Dispenser

Kod Code	Lt Lt	Koli/Adet Pcs/Ctn
55011212	6,4	1



» Lux İecek Dispenseri
Lux Juice Dispenser

Kod Code	Lt Lt	Koli/Adet Pcs/Ctn
54012112	12	1



» Lux Kahve Dispenseri
Lux Coffee Dispenser

Kod Code	Lt Lt	Koli/Adet Pcs/Ctn
54012212	12	1



» Meyve Suyu Dispenseri
Juice Dispenser

Kod Code	Ölü (cm) Dim. (cm)	Lt Lt	Koli/Adet Pcs/Ctn
59039021	37x23x60	7	1
59039022	37x45x69	14	1



» Premium İecek Dispenseri
Premium Juice Dispenser

Kod Code	Lt Lt	Koli/Adet Pcs/Ctn
54011112	12	1



» Premium Kahve Dispenseri
Premium Coffee Dispenser

Kod Code	Lt Lt	Koli/Adet Pcs/Ctn
59011019	19	1



» Lux Süt Dispenseri
Lux Milk Can

Kod Code	Lt Lt	Koli/Adet Pcs/Ctn
54011212	6	1

- Kendinden buz hazneli kapak
- Lid has self ice store



» Carina Corn Flakes Dispenseri
Carina Sereal Dispenser

Kod Code	Lt Lt	Koli/Adet Pcs/Ctn
55011231	3,7	1
55011232	2x3,7	1
55011233	3x3,7	1



» Corn Flakes Dispenseri
Corn Flakes Dispenser

Kod Code	Ölçü (cm) Dim. (cm)	Lt Lt	Koli/Adet Pcs/Ctn
54021231	42x23x62	7,5	1
54021232	42x45x62	15	1



» Corn Flakes Dispenseri
Corn Flakes Dispenser

Kod Code	Model Model	Koli/Adet Pcs/Ctn
40010001	Tekli/Single	1
40010002	2'li/Double	1
40010003	3'lü/Triple	1



» Corn Flakes Dispenseri
Corn Flakes Dispenser

Kod Code	Lt Lt	Koli/Adet Pcs/Ctn
54010010	10	1

Sıcak Tutucu Lambalar /Heat Retaning Infrared Lamps



- Kumanda anahtarlı açma kapama kontrolü
- Asansörlü ayarlanabilir uzunluk 55-130 cm
- 230 Volt / 1 Ph. / 50 Hz; 250 W
- Hem BOH (Back of the House) hem de FOH (Front of the House) kullanım için özel tasarım



470 471 472 473

» Klasik Infrared Lamba Classic Infrared Lamp

MASA

Kod Code	Renk Colour	Øxh (mm) Øxh (mm)	Koli/Adet Pcs/Ctn
47010006	Krom/Chrome	245x260	1
47110006	Pirinç/Brass	245x260	1
47210006	Bakır/Copper	245x260	1
47310006	Siyah/Black	245x260	1

* Fiyata infrared ampül dahildir.

* w/infrared bulb



- Adjustable helix cable (55 - 130 cm)
- 230 Volt / 1 Ph. / 50 Hz; 250 W
- Suitable for both BOH (Back of the House) and FOH (Front of the House) using
- On - Off Switch



473 471 474 475

» Dome Infrared Lamba Dome Infrared Lamp

MASA

Kod Code	Renk Colour	Øxh (mm) Øxh (mm)	Koli/Adet Pcs/Ctn
47310014	Siyah/Black	270x320	1
47110014	Pirinç/Brass	270x320	1
47410014	Antrasit/Anthracite	270x320	1
47510014	Bordo/Maroon	270x320	1

* Fiyata infrared ampül dahildir.

* w/infrared bulb

152



476 471 472 475

» Vintage Infrared Lamba Vintage Infrared Lamp

MASA

Kod Code	Renk Colour	Øxh (mm) Øxh (mm)	Koli/Adet Pcs/Ctn
47610015	Koyu Yeşil/Dark Green	310x265	1
47110015	Pirinç/Brass	310x265	1
47210015	Bakır/Copper	310x265	1
47510015	Bordo/Maroon	310x265	1

* Fiyata infrared ampül dahildir.

* w/infrared bulb

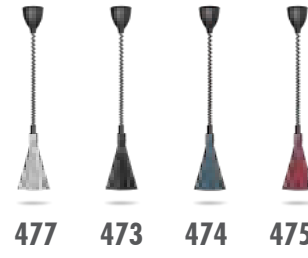

477 473 474 475

» Konik Infrared Lamba Conic Infrared Lamp

MASA

Kod Code	Renk Colour	Øxh (mm) Øxh (mm)	Koli/Adet Pcs/Ctn
47710016	Parlak Alu./Anodised Alu.	155x270	1
47310016	Siyah/Black	155x270	1
47410016	Antrasit/Anthracite	155x270	1
47510016	Bordo/Maroon	155x270	1

Sıcak Tutucu Lambalar /Heat Retaning Infrared Lamps

- Kısaltılabilir Askı Borusu : h. 140 cm
- 230 Volt / 1 Ph. / 50 Hz; 250 W
- Hem BOH (Back of the House) hem de FOH (Front of the House) kullanım için özel tasarım

- Hanging Rod: h:140 cm
- Can be shortened
- Suitable for both BOH (Back of the House) and FOH (Front of the House) using
- On - Off Switch



MASA

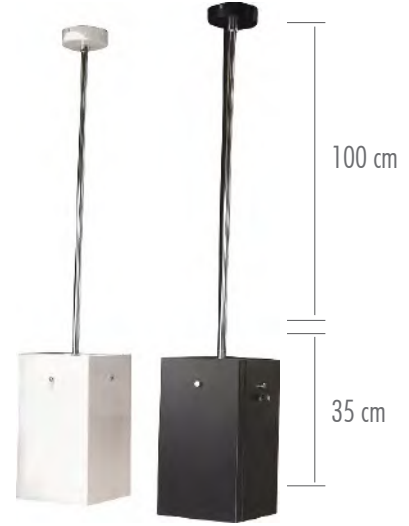

- » Infrared Kare Lamba
Infrared Square Lamp

Kod Code	Renk Colour	Ölçü (cm) Dim. (cm)	Koli/Adet Pcs/Ctn
47010009	Beyaz/White	20x20x35	1
47110009	Siyah/Black	20x20x35	1

- * Fiyata infrared ampül dahildir.
* w/infrared bulb



- » Tavan Askı Rayı 3 Lambalı
Hanger Unit (for 3 Lamp)

MASA

Kod Code	Yükseklik (cm) Height (cm)	Ölçü (cm) Dim. (cm)	Koli/Adet Pcs/Ctn
47010007	50 - 100	110	1

* Ayarlanabilir yükseklik. * Adjustable height



- » Tavan Askı Rayı 4 Lambalı
Hanger Unit (for 4 Lamp)

MASA

Kod Code	Yükseklik (cm) Height (cm)	Ölçü (cm) Dim. (cm)	Koli/Adet Pcs/Ctn
47010008	50 - 100	140	1

* Ayarlanabilir yükseklik. * Adjustable height

- Askı rayı lambaların 100 cm daha aşağıya inmesini sağlar
- Tavanın yüksek olduğu ve yan yana birden fazla ısıtıcı lamba kullanılması gereken durumlarda askı rayı monte edilebilir.

- Lowers infrared lamps 100 cm
- Can be use when ceiling is too high or need to hang more than one infrared lamp

153



- » Infrared Isıtıcı Tekli Lamba (Ayaklı)
Self Standing Single Heat Lamp

Kod Code	Ölçü (cm) Dim. (cm)	Güç Power	Koli/Adet Pcs/Ctn
47010003	22x28x70	250 W	1

- * Fiyata infrared ampül dahildir. * w/infrared bulb



- » Infrared Isıtıcı Çiftli Lamba (Ayaklı)
Self Standing Double Heat Lamp

Kod Code	Ölçü (cm) Dim. (cm)	Güç Power	Koli/Adet Pcs/Ctn
47010004	50x30x70	2x250 W	1

- * Fiyata infrared ampül dahildir. * w/infrared bulb

KAPP



154

» Sıcak Tutucu Isıtıcı Lambalı Set
Heat Lamp w/Warming Plate

MASA

Kod Code	Model Model	Ölçü (cm) Dim. (cm)	Koli/Adet Pcs/Ctn
47013011	1/1	40x60	1

* Fiyata infrared ampül dahildir. * w/infrared bulb

» Sıcak Tutucu Isıtıcı Lambalı Set
Heat Lamp w/Warming Plate

MASA

Kod Code	Model Model	Ölçü (cm) Dim. (cm)	Koli/Adet Pcs/Ctn
47013021	2/1	71x59	1

* Fiyata infrared ampül dahildir. * w/infrared bulb

- Komple paslanmaz çelik gövde
- Buz aküsü ile uzun süreli soğuk tutma
- Tüm GN küvetler ile uyumlu
- S/S Body
- Chilling with ice pack
- Suitable for all GN pans

- Komple paslanmaz çelik gövde
- 0°C - 60°C termostat kontrolü
- 200 W ısı ayarı
- S/S Body
- Keeps warm between 0°C - 60°C w/Thermic control
- 200 W



» Soğuk Tutucu Servis Ünitesi
Cold Plate

MASA

Kod Code	Model Model	Ölçü (cm) Dim. (cm)	Koli/Adet Pcs/Ctn
47012011	1/1	40x60	1
47012021	2/1	71x59	1



» Sıcak Tutucu Servis Ünitesi
Hot Plate

MASA

Kod Code	Model Model	Ölçü (cm) Dim. (cm)	Koli/Adet Pcs/Ctn
47010011	1/1	40x60	1
47010021	2/1	71x59	1



MASA

» Carving Station Tek Lambalı
Carving Station Single Lamp

Kod Code	Renk Colour	Ölçü (mm) Dim. (mm)	Koli/Adet Pcs/Ctn
47113011	Açık/Light	640x830x750	1
47113111	Koyu/Dark	640x830x750	1

* Fiyata infrared ampül dahildir. * w/infrared bulb



30-90° Termostat kontrollü
Temperli cam yüzey
Tabla ısıtıcısı 750W
Plexiglass nefeslik
Işıklı on-off switchi
Spiralli ısıtıcı lamba (250W)
Krom kaplı lamba
220-240V

30-90° Digital termostat
Heat retaining tempered glass
Plexiglass sneeze guard
On-off switch
Flexible arm
Chrome coated
220-240 V

155



MASA



30-90° Termostat kontrollü
Temperli cam yüzey
Tabla ısıtıcısı 750W
Plexiglass nefeslik
Işıklı on-off switchi
Spiralli ısıtıcı lamba (2x250W)
Krom kaplı lamba
220-240V

30-90° Digital termostat
Heat retaining tempered glass
Plexiglass sneeze guard
On-off switch
Flexible arm
Chrome coated
220-240 V

» Carving Station Çift Lambalı
Carving Station Double Lamp

Kod Code	Renk Colour	Ölçü (mm) Dim. (mm)	Koli/Adet Pcs/Ctn
47113021	Açık/Light	640x830x750	1
47113121	Koyu/Dark	640x830x750	1

* Fiyata infrared ampül dahildir. * w/infrared bulb



» Stand
Stand

Kod Code	Ölçü (cm) Dim. (cm)	Koli/Adet Pcs/Ctn
58026012	60x30x12	1



» Katlı Meyvelik Standı
Fruit Stand

Kod Code	Model Model	Ölçü (cm) Dim. (cm)	Koli/Adet Pcs/Ctn
40290001	2 Katlı / 2 Tiered	17	1
40290002	3 Katlı / 3 Tiered	28	1



» Pasta Standı
Cake Stand

Kod Code	Øxh (cm) Øxh (cm)	Koli/Adet Pcs/Ctn
32502005	20x5	2
32502205	22x5	2
32502405	24x5	2
32503005	30x5	2
32503605	36x5	2
32502210	22x10	2
32502410	24x10	2
32503010	30x10	2
32503610	36x10	2

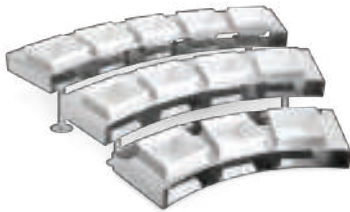

» Yay Sunumluk Standı
Bowl Display Stand

Kod Code	Ölçü (cm) Dim. (cm)	Koli/Adet Pcs/Ctn
40341358	3xStand 46x5	1
40341357	4xStand 57x10,5	1
40341356	5xStand 67x16	1
58020909	Melamin Kase 9x9x5,5 Melamine Square Plate 9x9x5,5	1



» Sunum Kaşığı Standı
Amuse Bouche Spoon Stand

Kod Code	Ölçü (cm) Dim. (cm)	Kapasite Capacity	Koli/Adet Pcs/Ctn
40160150	15x34	36 Kaşık/36 Spoons	1
40160151	30x37	60 Kaşık/60 Spoons	1

* Fiyata sunum kaşıkları dahil değildir.
*w/o Amuse Bouche Spoons



» Sunum Kaşığı
Amuse Bouche Spoon

Kod Code	Ölçü (mm) Dim. (mm)	Koli/Adet Pcs/Ctn
40150500	4,5	12
40150501	6,5	12



» Pasta / Kek Fanusu
Cake Stand w/Cover

Kod Code	Model Model	Ölçü (cm) Dim. (cm)	Koli/Adet Pcs/Ctn
80010005	Yuvarlak / Round	30,5x30,5x11,5	6
80010007	Baton / Tangular	39x16,5x12,5	6



» Yumurta Standı (Isıtmalı)
Egg Stand w/Heater

Kod Code	Ölçü (cm) Dim. (cm)	Koli/Adet Pcs/Ctn
40200001	26x40x15 (24 Gözlü/24 Partition)	1
40200000	32x52x15 (32 Gözlü/32 Partition)	1

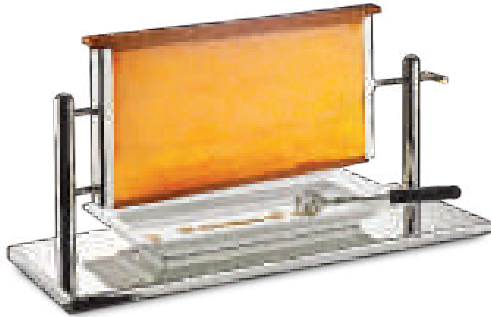

» Petek Bal Standı
Honey Comb Stand

Kod Code	Ölçü (cm) Dim. (cm)	Koli/Adet Pcs/Ctn
40340090	23x68x32	1

* Porselen tabak ve bal kasığı fiyata dahil değildir.
* w/o porcelain plate



» Çatal Kasık Standı
Cutlery Stand

Kod Code	Ölçü (cm) Dim. (cm)	Koli/Adet Pcs/Ctn
40160223	43x15x19	1

*Hazne ölçü: Ø 13, Derinlik: 14
*Chamber: Ø 13, Depth: 14





» Tulip
Tulip

Kod Code	Ölçü (cm) Dim. (cm)	Koli/Adet Pcs/Ctn
58021075	10x7,5x5	12
580 581		
 		





» Rose
Rose

Kod Code	Ölçü (cm) Dim. (cm)	Koli/Adet Pcs/Ctn
58021008	10x7,8x3,5	12
580 581		
 		



» Daisy
Daisy

Kod Code	Ölçü (cm) Dim. (cm)	Koli/Adet Pcs/Ctn
58020808	8x8x3,3	12
580 581		
 		

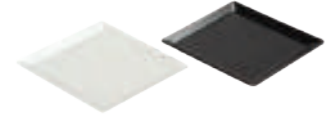



» Leaf
Leaf

Kod Code	Ölçü (cm) Dim. (cm)	Koli/Adet Pcs/Ctn
58021010	10x10	12
580 581		
 		







» Lily
Lily

Kod Code	Ölçü (cm) Dim. (cm)	Koli/Adet Pcs/Ctn
58021007	10x7x2,5	12
580 581		
 		







» Begonia
Begonia

Kod Code	Kapasite Capacity	Koli/Adet Pcs/Ctn
46010030	30 ml	96
46011060	60 ml	96
460 462 465 466		
   		



» Petunia Sosluk/Reçellik **plast|port®**
Petunia PC Sauce Cup

Kod Code	Kapasite Capacity	Koli/Adet Pcs/Ctn
46010040	40 ml	160
46010055	55 ml	160
460 461 462 463 464		
    		



» Kare Kase
Square Plate

Kod Code	Ölçü (cm) Dim. (cm)	Koli/Adet Pcs/Ctn
58021313	13x13x7	12



» Yuvarlak Kase
Round Bowl

Kod Code	Ölçü (cm) Dim. (cm)	Koli/Adet Pcs/Ctn
58021307	Ø 13x7	12



» Petunia Sosluk/Reçellik **plast|port®**
Petunia PC Sauce Cup

Kod Code	Kapasite (ml) Capacity (ml)	Koli/Adet Pcs/Ctn
46020220	220	108



» Küp Ahsap Yükseltici
Square Wood Riser

Kod Code	Ölçü (cm) Dim. (cm)	Koli/Adet Pcs/Ctn
69011010	10x10x10	1
69011515	15x15x15	1
69012020	20x20x20	1

» Altıgen Ahsap Yükseltici
Sextagon Wood Riser

Kod Code	Ölçü (cm) Dim. (cm)	Koli/Adet Pcs/Ctn
69021414	14x10	1
69021919	19,5x10	1
69022525	25x10	1



» Yükseltici Ayaklar
Elevator Feet

Kod Code	Ölçü (cm) Dim. (cm)	Koli/Adet Pcs/Ctn
40100900	6x6	1
40100901	11,5x6	1
40100902	16,5x6	1



» Makas Yükseltici
Elevator Shears Model

Kod Code	Ölçü (cm) Dim. (cm)	Koli/Adet Pcs/Ctn
40601811	21x21x7	1
40601812	21x21x12	1
40601813	21x21x17	1

Kayrak Sunumluklar /Slate Display Plates

- Volkanik külle yoğunlaşan taş ısıyı homojen bir şekilde yayar ve yiyecekleri sıcak tutar
- Buzdolabında tutulan kayrak taşı soğuk servisler için ideal
- Kayrak taşının doğallığı, dokusu ve koyurengi sunumlara şıklık katar
- Zeytinyağıyla kolayca parlatılabilir
- Yapışma yapma, kolay temizlenir
- Bulaşık makinesinde yıkanabilir
- Ocak üstü ve mikrodalgada kullanılmaz



- Homogeneous heat distribution keeps foods warm
- For cold serving keep slates in fridge
- Dark colour, pattern and naturality of slate stone makes your presentations elegant
- You can polish your plates with olive oil easily
- Non-stick, easy cleaning
- High-heat resisting
- Dishwasher safe
- Do not use on direct flame or in microwave



» Kayrak Sunum Tabak Natural Kenar
Slate Display Plate Natural Edge

Kod Code	Ölçü (cm) Dim. (cm)
78001020	10x20
78001530	15x30
78002030	20x30
78001545	15x45
78001200	25x35
78003045	30x45



» Dikdörtgen Oluklu Sunum Tabak
Slate Rectangular Grooved Display Plate

Kod Code	Ölçü (cm) Dim. (cm)
78003020	20x30
78002535	25x35
78004030	28x40



» Kayrak Kare Oluklu Tabak
Slate Square Grooved Display Plate

Kod Code	Ölçü (cm) Dim. (cm)
78001515	15x15
78002020	20x20
78002525	25x25
78003030	30x30

160





» Kayrak Yuvarlak Tabak Natural Kenar
Slate Round Display Plate Natural Edge

Kod	Ø (cm)
Code	Ø (cm)
78002850	30



» Kayrak 3 Katlı Sunumluk
Slate Display Stand

Kod	Model	h (cm)	Ø (cm)
Code	Model	h (cm)	Ø (cm)
78000002	2 Katlı/2 Tiered	23	20/25
78000003	3 Katlı/3 Tiered	33	20/25,5/30



» Banket Tepsisi Kenar Desenli
Figured Tray for Open Buffet

Kod Code	Ölçü (cm) Dim. (cm)	Koli/Adet Pcs/Ctn
31611005	530x325	6



» Kırılmaz Tepsisi
Cake stand

Kod Code	Ölçü (cm) Dim. (cm)	Koli/Ad. Pcs/Ctn
430 30030	10x30	100
430 31530	15x30	50
430 32030	20x30	50
430 32540	25x40	50

430 Şeffaf Transparent	431 Beyaz White	432 Siyah Black	433 Kırmızı Red



» 1/1 GN Tepsisi
1/1 GN Tray

Kod Code	Ölçü (mm) Dim. (mm)	lt	Koli/Adet Pcs/Ctn
31611010	530x325x10	1,25	6
31611020	530x325x20	2,5	6
31611040	530x326x40	5	6

» 2/3 GN Tepsisi
2/3 GN Tray

Kod Code	Ölçü (mm) Dim. (mm)	lt	Koli/Adet Pcs/Ctn
31623010	354x325x10	0,75	6
31623020	354x325x20	1,5	6
31623040	354x325x40	3	6

» 1/2 GN Tepsisi
1/2 GN Tray

Kod Code	Ölçü (mm) Dim. (mm)	lt	Koli/Adet Pcs/Ctn
31612010	325x265x10	0,5	6
31612020	325x265x20	1,25	6
31612040	325x265x40	2,5	6



» Kayık Tabak
Boat Bowl

Kod Code	Ölçü (cm) Dim. (cm)	Koli/Adet Pcs/Ctn
58015252	Ø 21x13,2	1



» Çift Cıdarlı Derin Tabak
Deep Bowl D/W

Kod Code	Ø xh (cm) Ø xh (cm)	Koli/Adet Pcs/Ctn
58012513	25x13	1



» Çift Cıdarlı Konik Tabak
Conical Bowl D/W

Kod Code	Ø xh (cm) Ø xh (cm)	Koli/Adet Pcs/Ctn
58020034	34,5	1



» Baget Ekmeklik
Baguette Basket (S/S)

Kod Code	Ölçü (cm) Dim. (cm)	Koli/Adet Pcs/Ctn
40100131	Ø 27x31	1
40100132	Ø 27x40	1



» Ekmek Sepeti
Bread Basket (S/S)

Kod Code	Ölçü (cm) Dim. (cm)	Koli/Adet Pcs/Ctn
40101151	21x17x6	1
40101152	30x21x6	1
40101153	35x23,5x10	1
40101154	45x32x10	1

- %100 ahşap görümlü
- Bakteri barındırmaz
- +85°C / -40°C arası ısı dayanıklılığı
- Bulaşık makinesinde yıkanabilir
- Esnek malzemeden imal edilmiştir
- %100 wood view
- Unbacterialised
- Heat intensive and endurance up to +85 and -40+85°C / -40°C
- Dishwasher safe
- Manufactured from elastic materials



» Derin Kase
Deep Bowl

Kod Code	Ø (cm) Ø (cm)	Koli/Adet Pcs/Ctn
80011012	12,5	30
80011016	16	12
80011020	20	12
80011024	24	12



» Kare Derin Tabak
Square Deep Bowl

Kod Code	Ölçü (cm) Dim. (cm)	Koli/Adet Pcs/Ctn
80010100	10x10x3,5	36
80010111	12,5x12,5x6	30
80010112	19,5x19,5x9,5	12
80010113	24x24x10,5	12
80010114	29x29x11	12
80010115	36x36x12	12



» Üçgen Derin Tabak
Triangle Deep Bowl

Kod Code	Ölçü (cm) Dim. (cm)	Koli/Adet Pcs/Ctn
80011100	10x3,5	36
80011111	12x6	30
80011112	19,5x10	12
80011113	24x10,5	12
80011114	29x11	12
80011115	36x12	12



» Oval Tabak
Eliptic Bowl

Kod Code	Ölçü (cm) Dim. (cm)	Koli/Adet Pcs/Ctn
80012230	22x30x8	12
80013624	36x24x8,5	12
80012740	27x40x8,5	12



» Yuvarlak Tabak
Round Bowl

Kod Code	Ölçü (cm) Dim. (cm)	Koli/Adet Pcs/Ctn
80010015	Ø 16x4	24
80010020	Ø 21x5,5	12
80010025	Ø 26x7	12
80010030	Ø 30x8	12



» Yaprak Tepsi
Leaf Display Tray

Kod Code	Ölçü (cm) Dim. (cm)	Koli/Adet Pcs/Ctn
80010211	25x45x3	6
80010212	33x57x3	6



» Elit Tepsi
Elite Tray

Kod Code	Ölçü (cm) Dim. (cm)	Koli/Adet Pcs/Ctn
80010133	31x39	6
80010134	35x42	6



» Sunum Tepsi
Display Tray

Kod Code	Ölçü (cm) Dim. (cm)	Koli/Adet Pcs/Ctn
80010208	9x35,5x4	6
80010209	23x46x5	6
80010210	33x55x5	6



» Kare Tabak
Square Bowl

Kod Code	Ölçü (cm) Dim. (cm)	Koli/Adet Pcs/Ctn
80012323	23x23x7	12
80012828	28x28x7,5	12



» Meze Kuveti
Appetizer Pan

Kod Code	Ölçü (cm) Dim. (cm)	Koli/Adet Pcs/Ctn
80012818	28x18,5x4	6
80013323	33x23x4	6
80013826	38x26x4	6



Restaurant/ Table-Top

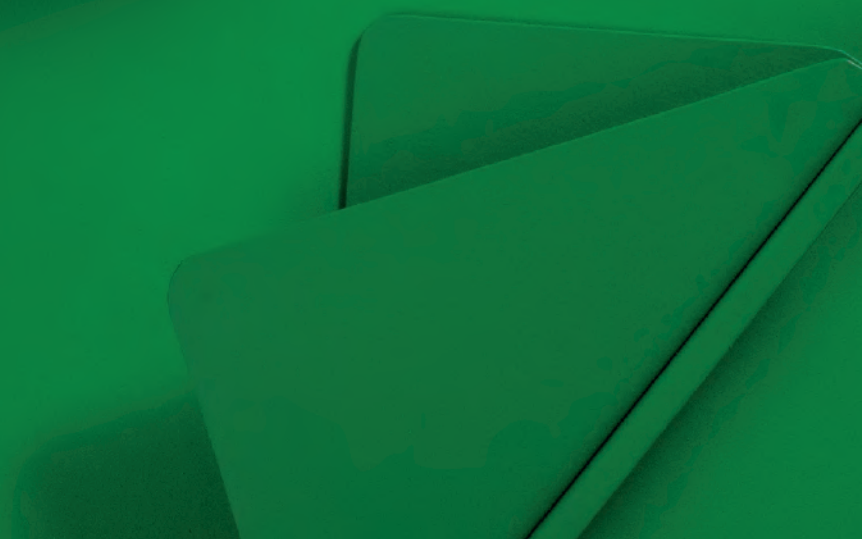





» Kayrak Yuvarlak Tabak
Slate Round Plate

Kod Code	Ø (cm) Ø (cm)
78002850	30



- Volkanik külle yoğunlaşan taş ısıyı homojen bir şekilde yayar ve yiyecekler sıcak tutar
- Buzdolabında tutulan kayrak taşı soğuk servisler için ideal
- Kayrak taşının doğallığı, dokusu ve koyu rengi sunumlara şıklık katar
- Zeytinyağıyla kolayca parlatılabilir
- Yapışma yapma, kolay temizlenir
- Bulaşık makinesinde yıkanabilir
- Ocak üstü ve mikrodalgada kullanılmaz

- *Homogeneous heat distribution keeps foods warm*
- *For cold serving keep slates in fridge*
- *Dark colour, pattern and naturalness of slate stone makes your presentations elegant*
- *You can polish your plates with olive oil easily*
- *Non-stick easy cleaning*
- *High-heat resisting*
- *Dishwasher safe*
- *Do not use on direct flame or in microwave*



» Kayrak Sunum Tabak Natural Kenar
Slate Display Plate Natural Edge

Kod Code	Ölçü (cm) Dim. (cm)
78001020	10x20
78001530	15x30
78002030	20x30
78001545	15x45
78001200	25x35
78003045	30x45



» Dikdörtgen Oluklu Sunum Tabak
Slate Rectangular Grooved Display Plate

Kod Code	Ölçü (cm) Dim. (cm)
78003020	20x30
78002535	25x35
78004030	28x40



» Kayrak Kare Tabak
Slate Square Plate

Kod Code	Ölçü (cm) Dim. (cm)
78001515	15x15
78002020	20x20
78002525	25x25
78003030	30x30



» Kayrak 2 Katlı Sunumluk
Slate Display Stand 2 Tiered

Kod Code	h (cm) h (cm)	Ø (cm) Ø (cm)
78000002	23	20/25



» Kayrak 3 Katlı Sunumluk
Slate Display Stand 3 Tiered

Kod Code	h (cm) h (cm)	Ø (cm) Ø (cm)
78000003	33	20/25,5/30

Ahşap Sunumluklar / Wooden Displays



» Boga Steak Tahtası
Bull Steak Display

Kod Code	Ölçü (cm) Dim. (cm)
69012637	26x37



» Saplı Steak Tahtası
Display w/handle

Kod Code	Ölçü (cm) Dim. (cm)
69012043	20x43
69012547	25x47
69013242	32x42



» Klasik Steak Tahtası
Classic Display

Kod Code	Ölçü (cm) Dim. (cm)
69012335	23x35
69012538	25,5x38,5



170



» Geometrik Sunumluk
Geometrical Display

Kod Code	Ölçü (cm) Dim. (cm)
69012038	20x38



» Saplı Peynir Sunumluk
Cheese Display w/handle

Kod Code	Ölçü (cm) Dim. (cm)
69011547	15x47



» Klasik Peynir Sunumluk
Classic Cheese Display

Kod Code	Ölçü (cm) Dim. (cm)
69011635	16x35



» Saplı Pizza Sunumluk (Ireko)
Pizza Display w/handle (Ireko)

Kod Code	Ø (cm) Ø (cm)
69010028	28



» Yuvarlak Sunumluk (Ireko)
Round Display (Ireko)

Kod Code	Ø (cm) Ø (cm)
69011028	28



» Elips Sunumluk (Ireko)
Elips Display (Ireko)

Kod Code	Ölçü (cm) Dim. (cm)
69012745	17x45



* Ahşap Sunumluklar tekli satılmaktadır * Wooden Displays are sold individually



» PC Düz Tabak
PC Flat Plate

Kod Code	Ø (cm) Ø (cm)	Koli/Adet Pcs/Ctn
46040013	13	100
46040015	15	100
46040017	17	108
46040019	19	108
46040021	21	108
46040023	23	72
46040025	25	72
46040028	28	72



» PC Çukur Tabak
PC Soup Plate

Kod Code	Ø (cm) Ø (cm)	Koli/Adet Pcs/Ctn
46030019	19	72
46030021	21	72



» PC Oluklu Tabak
PC Ribbed Plate

Kod Code	Ø (cm) Ø (cm)	Koli/Adet Pcs/Ctn
46050017	17	72
46050018	18,5	72



» PC Pizza Tabağı
PC Pizza Plate

Kod Code	Ø (cm) Ø (cm)	Koli/Adet Pcs/Ctn
46050032	32	24



» PC Kare Kayık Tabak
PC Appetizer Plate

Kod Code	Ölçü (cm) Dim. (cm)	Koli/Adet Pcs/Ctn
46020210	12	108
46020014	14	108
46020017	17	108
46020020	20	108



» PC Kayık Tabak
PC Shallow Platter

Kod Code	Ölçü (cm) Dim. (cm)	Koli/Adet Pcs/Ctn
46011114	14	108
46010024	24	72
46010029	29	48
46010034	34	24



» PC Çorba Kasesi & Kapak
PC Bowl & Cover

Kod Code	Model Model	Ø (cm) Ø (cm)	Koli/Adet Pcs/Ctn
46050012	Kase/Bowl	12	108
46150017	Kapak/Cover	12	108



» PC Tabak Kapağı
PC Plate Cover

Kod Code	Ø (cm) Ø (cm)	Koli/Adet Pcs/Ctn
46050023	23,5	72



» PC Kayık Tabak Kapağı
PC Appetizer Plate Cover

Kod Code	Ölçü (cm) Dim. (cm)	Koli/Adet Pcs/Ctn
46010224	24	72

marlux



- Monoblok gövde çatlamalara ve kırılmalara karşı dayanıklı
- Öğütme boyutu değirmenin üst kısmındaki topuzda ayarlanır. Ne kadar sıkarsanız o kadar ince öğütür. Eğer topuzu gevşetirseniz öğütme daha iri taneler elde edersiniz. En iyi öğütme işlemini gerçekleştirmek için değirmeni daima aynı yönde çevirin.
- Karabiber için yüksek kaliteli kesilmiş ve sertleştirilmiş çelik mekanizma değirmenler.
- Tuz değirmenleri için paslanmaz çelik mekanizma. Çelik mekanizmalar üretim hatalarına karşı ömür boyu garantilidir. Yanlış kullanımdan kaynaklanan zararları kapsamaz.
- Akdeniz gibi nemli bölgelerde paslanmayı önlemek için seramik mekanizma. Seramik Mekanizmalı değirmenler için garanti süresi üç yıldır
- Çelik mekanizmalı bir karabiber değirmeni asla tuz ile doldurulmamalıdır. Tuz aşırıdır ve mekanizmaya geri dönülmez bir hasar verir. Tuz değirmeni kendine ait paslanmaz çelik mekanizmaya sahiptir.

- Monoblock body against cracking and breaking
- The grinding size is set by adjusting the knob on the top of the mill : the more you tighten it up, the finer the grinding (spicy but less flavored). If you loosen it, the coarser the grinding is (flavored but less spicy). Always rotate the mill top in the same direction to get the best grinding
- These mills made of wood are available with different mechanisms:
- With high quality cut and hardened steel mechanism for pepper mills.
- With stainless steel mechanism for salt mills. These steel mechanism are lifetime guaranteed against manufacturing defects, within a normal use and does not cover damages caused by shock or misuse.
- With a ceramic mechanism for spice mills (coarse white salt, coarse sea salt, mixed peppercorns, herbes de Provence). These mills are guaranteed against manufacturing defects for three years. The upper knob sets grinding size. These mills are delivered empty.
- The pepper mill with a steel mechanism must never be filled with salt : the salt is corrosive and will irreversibly damage the mechanism. The salt mill has its own mechanism made of a s/s which has been specially treated against salt corrosion.

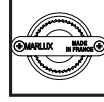

» Java Dark Karabiber Değirmeni
Java Dark Pepper Mill

Kod Code	Ölçü (cm) Dim. (cm)	Koli/Adet Pcs/Ctn
66022214	14	1
66022221	21	1
66022225	25	1
66022230	30	1
66022240	40	1
66022280	80	1

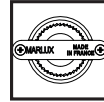

Çelik Karabiber Değirmeni Mekanizması
Steel Pepper Mill Mechanism



Paslanmaz Çelik Tuz Değirmeni Mekanizması
S/S Salt Mill Mechanism



Seramik Değirmeni Mekanizması
Ceramic Mill Mechanism



» Java Natural Karabiber Değirmeni
Java Natural Pepper Mill

Kod Code	Ölçü (cm) Dim. (cm)	Koli/Adet Pcs/Ctn
66022114	14	1
66022121	21	1
66022125	25	1
66022130	30	1
66022140	40	1
66022180	80	1







NEW

Seramik Mekanizma
Ceramic Mechanism



» Polka Matte S/S
Polka Matte S/S

Kod Code	Model Model	Ölçü (cm) Dim. (cm)	Koli/Adet Pcs/Ctn
66041014	Tuz /Salt	14	1
66042014	Karabiber / Pepper	14	1

Seramik Mekaniz
Ceramic Mechanis



» Hip Hop Dark
Hip Hop Dark

Kod Code	Model Model	Ölçü (cm) Dim. (cm)	Koli/Adet Pcs/Ctn
66031211	Tuz /Salt	11	1
66032211	Karabiber / Pepper	11	1

S/S Mekanizma
S/S Mechanism



Çelik Mekanizma
Steel Mechanism



» Rumba
Rumba

Kod Code	Model Model	Ölçü (cm) Dim. (cm)	Koli/Adet Pcs/Ctn
66051320	Tuz /Salt	20	1
66052320	Karabiber / Pepper	20	1

S/S Mekanizma
S/S Mechanism



Çelik Mekanizma
Steel Mechanism



» Paso Dark
Paso Dark

Kod Code	Model Model	Ölçü (cm) Dim. (cm)	Koli/Adet Pcs/Ctn
66011210	Tuz /Salt	10	1
66012210	Karabiber / Pepper	10	1

S/S Mekanizma
S/S Mechanism



Çelik Mekanizma
Steel Mechanism



» Paso Natural
Paso Natural

Kod Code	Model Model	Ölçü (cm) Dim. (cm)	Koli/Adet Pcs/Ctn
66011110	Tuz /Salt	10	1
66012110	Karabiber / Pepper	10	1



» Ahsap Degirmen (Çelik Bıçaklı)
Rubber Wood (S/S Grinder)

Kod Code	Model Model	Ölçü (cm) Dim. (cm)	Koli/Adet Pcs/Ctn
53011013	Tuzluk / Salt Sprinkler	13	4
53012013	Değirmen / Pepper Mill	13	4
53011021	Değirmen / Pepper Mill	21	2
53011031	Değirmen / Pepper Mill	31	2
53011041	Değirmen / Pepper Mill	41	1
53011046	Değirmen / Pepper Mill	46	1



» Tuzluk & Biberlik Set
Salt & Pepper Set

Kod Code	Ölçü (cm) Dim. (cm)	Koli/Adet Pcs/Ctn
62010034	11	4



» Sütun Set
Pillar Set

Kod Code	Ölçü (cm) Dim. (cm)	Koli/Adet Pcs/Ctn
53040720	8	1



» Polikarbonat Tuzluk&Biberlik **plast|port®**
PC Salt & Pepper

Kod Code	Model Model	Koli/Adet Pcs/Ctn
46010070	Tuzluk / Salt Sprinkler	40
46010071	Karabiberlik / Pepper Sprinkler	40
46010074	Kürdanlıklı Set/ Set w/Toothpick	48



» Venüs Tuzluk & Karabiberlik Takımı
Venus Salt & Pepper Set (S/S)

Kod Code	Koli/Adet Pcs/Ctn
36306005	1



» Çelik Tuzluk & Karabiberlik Takımı
Salt & Pepper Set (S/S)

Kod Code	Koli/Adet Pcs/Ctn
36306007	1

Yağlık & Sirkelik & Baharatlık / Condiment Sets

NEW



» Tuzluk & Karabiberlik Set Ahşap Standlı
Salt & Pepper Set w/Wooden Stand

Kod Code	Koli/Adet Pcs/Ctn
36306010	1

NEW



» Peçetelikli Tuzluk & Karabiberlik Set Ahşap Standlı
Salt & Pepper Set w/Napkin Holder w/Wooden Stand

Kod Code	Koli/Adet Pcs/Ctn
36306008	1

NEW



» Tuzluk & Karabiberlik /Baharat Set Ahşap Standlı
Salt & Pepper & Cruet Set w/Wooden Stand

Kod Code	Koli/Adet Pcs/Ctn
36306009	1

NEW



» 2'li Yağlık & Sirkelik Ahşap Standlı
Double Oil & Vinegar Set w/Wooden Stand

Kod Code	Kapasite Capacity	Koli/Adet Pcs/Ctn
36306020	2x250 ml	1

NEW



» 3'lü Yağlık & Sirkelik Ahşap Standlı
Triple Oil & Vinegar Set w/Wooden Stand

Kod Code	Kapasite Capacity	Koli/Adet Pcs/Ctn
36306030	3x250 ml	1

NEW



» İkili Baharatlık Ahşap Standlı
Double Cruet Set w/Wooden Stand

Kod Code	Koli/Adet Pcs/Ctn
36306022	1

177

NEW



» Üçlü Baharatlık
Triple Cruet Set

Kod Code	Koli/Adet Pcs/Ctn
36306006	1



» PC Sekerlik **plast|port®**
PC Sugar Bowl

Kod Code	Ölçü (cm) Dim. (cm)	Koli/Adet Pcs/Ctn
46010004	12x8	6



» PC Baharatlık **plast|port®**
PC Cruet

Kod Code	Ölçü (cm) Dim. (cm)	Koli/Adet Pcs/Ctn
46010006	6,8x5,7	6

KAPP

NEW



» Sufle Sunum Kaseesi
Ramekin

Kod Code	Ölçü (mm) Dim. (mm)	Koli/Adet Pcs/Ctn
37309550	95x50	1
37311030	110x30	

NEW



» Ahsap Sos Kutusu
Wooden Sauce Box

Kod Code	Ölçü (mm) Dim. (mm)	Koli/Adet Pcs/Ctn
37311040	110x40	1
37313030	130x30	1



» Bakır Sunum Kova
Copper Plated Display Bucket

Kod Code	Ölçü (cm) Dim. (cm)	Koli/Adet Pcs/Ctn
56130009	9	6
56130012	12	6

178



» Sunum Sandık
Wooden Display Box

Kod Code	Ölçü (cm) Dim. (cm)	Koli/Adet Pcs/Ctn
69001417	14x17	1
6900	6901	
İreko/Iroko	Kayın/Beachwood	



» Sunum Sandık Derin
Wooden Deep Display Box

Kod Code	Ölçü (cm) Dim. (cm)	Koli/Adet Pcs/Ctn
69002030	20x30	1
6900	6901	
İreko/Iroko	Kayın/Beachwood	



» Ahsap Sos Kutusu
Wooden Sauce Box

Kod Code	Ölçü (cm) Dim. (cm)	Koli/Adet Pcs/Ctn
69011422	14x22	1
69011527	15x27	1



» Konik Sunumluk
Conical Snack Holder

Kod Code	Ölçü (cm) Dim. (cm)	Koli/Adet Pcs/Ctn
60011001	18x10,4	6



» Dikdörtgen Sunum Sepeti
Rectangular Display Basket

Kod Code	Ölçü (cm) Dim. (cm)	Koli/Adet Pcs/Ctn
56032110	21x10x3,5	6

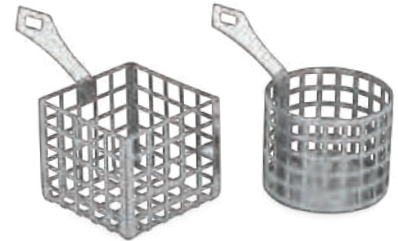

» Patates Sepeti
Miniature French Fries Basket

Kod Code	Ölçü (cm) Dim. (cm)	Koli/Adet Pcs/Ctn
40160501	7,5x7,5x6	1
40160502	Ø 7,5x6	1



» Kırıntı Küregi
Table Crumbler

Kod Code	Koli/Adet Pcs/Ctn
44010001	6



» Peçetelik
Napkin Holder

Kod Code	Ölçü (cm) Dim. (cm)	Koli/Adet Pcs/Ctn
56012111	15x3x10	6



» Peçetelik
Napkin Holder

Kod Code	Ölçü (cm) Dim. (cm)	Koli/Adet Pcs/Ctn
56011208	18,5x4,5x10,5	6



» Tabak Kapagı
Plate Cover

Kod Code	Ø (cm) Ø (cm)	Koli/Adet Pcs/Ctn
56011270	27	6
56011300	30	6



» Sunum Kapagı
Display Cover

Kod Code	Ø (cm) Ø (cm)	Koli/Adet Pcs/Ctn
40335005	20,5	1
40335006	23	1
40335007	26	1



» Sos Teknesi
Gravy Boat

Kod Code	Kapasite (ml) Capacity (ml)	Koli/Adet Pcs/Ctn
58010727	150	6
58010728	300	6



» Ayaklı Kadeh (Dondurmalık)
Ice Cream Cup

Kod Code	Ölçü (cm) Dim. (cm)	Koli/Adet Pcs/Ctn
35201000	6,5	1
35202000	8	1
35203000	9	1
35204000	10	1



» Dondurmalık
Ice Cream Cup

Kod Code	Ölçü (cm) Dim. (cm)	Koli/Adet Pcs/Ctn
35200001	8	1
35200002	8,5	1
35200003	9,5	1



» Kayık Kase
Boat Bowl

Kod Code	Ölçü (cm) Dim. (cm)	Koli/Adet Pcs/Ctn
58015252	Ø 21x13,2	6



» Ekmek Kasası
Bread Basket

Kod Code	Ölçü (cm) Dim. (cm)	Koli/Adet Pcs/Ctn
37302218	22x18x4,5	1



» Ekmek Kasası
Bread Basket

Kod Code	Ölçü (cm) Dim. (cm)	Koli/Adet Pcs/Ctn
37302015	20x15x8	1



» Çelik Ekmek Sepeti
Bread Basket (S/S)

Kod Code	Ölçü (cm) Dim. (cm)	Koli/Adet Pcs/Ctn
40101151	21x17x6	1
40101152	30x21x6	1



» Çelik Tel Ekmek Sepeti
Bread/Fruit Basket (S/S)

Kod Code	Ölçü (cm) Dim. (cm)	Koli/Adet Pcs/Ctn
57012210	Ø 20x10	6



» Köseli Ekmek Sepeti
Rectangular Basket

Kod Code	Ölçü (cm) Dim. (cm)	Koli/Adet Pcs/Ctn
80011118	14,5x21x5	18
80011119	18,5x25,5x7	12



» Oval Ekmek Sepeti
Oval Basket

Kod Code	Ölçü (cm) Dim. (cm)	Koli/Adet Pcs/Ctn
80011116	15x20x5	18
80011117	21x30x7,5	12



» Döküm
Casted Black Ashtray

Kod Code	Model Model	Ölçü (cm) Dim. (cm)	Koli/Adet Pcs/Ctn
43040004	Kare/Square	8x8x3,5	6
43040005	Yuvarlak/Round	Ø 9,3x4	6



» Döküm
Casted Ashtray

Kod Code	Model Model	Ölçü (cm) Dim. (cm)	Koli/Adet Pcs/Ctn
40350013	Kare/Square	8x8x3,5	6
43040001	Yuvarlak/Round	Ø 9,3x4	6



» Döküm Bronz
Casted Bronze Ashtray

Kod Code	Model Model	Ölçü (cm) Dim. (cm)	Koli/Adet Pcs/Ctn
43040002	Kare/Square	8x8x3,5	6
43040003	Yuvarlak/Round	Ø 9,3x4	6



» Ayaklı Küllük Stand
Ashtray Stand

Kod Code	h (cm) h (cm)	Koli/Adet Pcs/Ctn
40010004	76	1



» Kare Havuzlu
Square Ashtray w/Cover

Kod Code	Koli/Adet Pcs/Ctn
35930000	6



» Yuvarlak Havuzlu
Round Ashtray w/Cover

Kod Code	Koli/Adet Pcs/Ctn
35940000	6



» Havuzlu Rüzgarlıklı
Wind Protected Ashtray

Kod Code	Model Model	Koli/Adet Pcs/Ctn
43040011	Küçük / Small	10
43040010	Büyük / Big	10

İçecek/Beverage





- Zeminden pervane karıştırıcı
 - Hermetik kompresör
 - Hava soğutmalı kondenser
 - Polikarbon konteyner
 - Paslanmaz çelik gövde
- *Designed to cool all non-carbonated drinks*
 - *Easy to use and versatile*
 - *w/ Stirring paddle*
 - *Quick and easy cleaning*
 - *Hermetic compressor*
 - *Air cooled condenser*
 - *Shockproof polycarbonate food grade bowls*
 - *S/S structure*



ugolini

» Serbetlik

COMPACT 8/2

Juice Cooler

Kod Code	Kapasite (lt) Capacity (lt)	Ölçü (cm) Dim. (cm)
59040016	2x8	25x40x63

184

- Pompa püskürtmeli (şelale)
 - Hermetik kompresör
 - Hava soğutmalı kondenser
 - Polikarbon konteyner
 - Paslanmaz çelik gövde
- *Designed to cool all types of drinks (Natural fruit juices, coffee and tea, almond milk etc.)*
 - *Easy to use and versatile*
 - *w/ Fountain pump*
 - *Quick and easy cleaning*
 - *Hermetic compressor*
 - *Air cooled condenser*
 - *Shockproof polycarbonate food grade bowls*
 - *S/S structure*



ugolini

» Serbetlik

DELUX

Juice Cooler

Kod Code	Kapasite (lt) Capacity (lt)	Ölçü (cm) Dim. (cm)
59040012	12	18x47x57
59040024	12x2	36x47x57

ugolini



- Dijital termometre
- Hava soğutmalı kondenser
- Polikarbon konteyner
- Paslanmaz çelik gövde
- 220 V
- Kolay temizlenebilir
- *Designed for all natural fruit juices*
- *Designed to stir the juice even and perfect*
- *Easy to use and versatile*
- *w/ Stirring paddle*
- *w/Digital thermometer*
- *Quick and easy cleaning*
- *Hermatic compressor*
- *Air cooled condenser*
- *Shockproof polycarbonate food grade bowls*
- *S/S structure*
- *220 V*

A 19

» Ayran & Serbet Sogutucu
Cooler & Dispenser

Kod Code	Kapasite (lt) Capacity (lt)	Ölçü (cm) Dim. (cm)
59040019	19	35x38x71,3

185

ugolini



- Çift termostat
- Polikarbon konteyner
- Siyah boyalı gövde
- Geniş ağızlı musluklu
- 220 V, 1300 W
- Kolay temizlenebilir
- *Designed to mix hot chocolate and all thick drinks*
- *Easy to use and versatile*
- *w/ Stirring paddle*
- *w/Double thermostate*
- *Quick and easy cleaning*
- *Shockproof polycarbonate food grade bowls*
- *S/S structure*
- *220 V - 1300 Watt*

Delice

» Sıcak Çikolata / Sahlep Makinesi
Hot Chocolate Dispenser

Kod Code	Kapasite (lt) Capacity (lt)	Ölçü (cm) Dim. (cm)
59040005	5	26x32x49,5

- Manyetik sistem karıştırıcı
- Hermetik kompresör, arıza göstergesi
- Hava soğutmalı kondenser
- Polikarbon konteyner
- Paslanmaz çelik gövde

- Designed to make and dispense granitas & iced drinks
- Magnetic system stirrer
- Excl. patented magnetic transmission system
- Easy to use and versatile
- Quick and easy cleaning
- Hermetic compressor
- Air cooled condenser
- Shockproof polycarbonate food grade bowls
- S/S structure



ugolini

Minigel

» Dondurma Makinesi

Granita & Ice Slush Dispenser

Kod Code	Kapasite (lt) Capacity (lt)	Ölçü (cm) Dim. (cm)
59040006	6	19,5x48x61,5

186

- Manyetik sistem karıştırıcı
- Hermetik kompresör, arıza göstergesi
- Hava soğutmalı kondenser
- Polikarbon konteyner, aydınlatmalı
- Paslanmaz çelik gövde

- Designed to make and dispense granitas & iced drinks
- Magnetic system stirrer
- Excl. patented magnetic transmission system
- Easy to use and versatile
- Quick and easy cleaning
- Hermetic compressor
- Air cooled condenser
- Shockproof polycarbonate food grade bowls
- S/S structure



ugolini

MT 2

» Buzlu İçecek Makinesi / Ice Slush

Ice Slush Dispenser

Kod Code	Kapasite (lt) Capacity (lt)	Ölçü (cm) Dim. (cm)
59040020	2x10	36x47x69



» Blender (Kare Hazneli)
Blender (Square Jug)

Kod
Code
63010015



» Blender (Ses Geçirmez Kare Hazneli)
Blender (Square Jug w/Sound Enclosure)

Kod
Code
63020015



» Blender (Ses Geçirmez Yuvarlak Hazneli)
Blender (Round Jug w/Sound Enclosure)

Kod
Code
63010041



» Blender Yuvarlak Hazneli
Blender Round Jug

Kod
Code
63010014



» Blender Kare Hazneli
Blender Square Jug

Kod
Code
63010040



» Blender
Blender

Kod
Code
63010013

188



» İçecek Mikseri
Beverage Mixer

Kod
Code
63010011



» Narenciye Sıkacağı
Citrus Juicer

Kod
Code
63010016
63010017



Model
Model
Kapaksız / w/o Lid
Kapaklı / w/Lid



» Çay Otomatı
Tea Maker

Kod Code	Model Model	Kapasite (lt) Capacity (lt)
41011040	40 Bardak/Glasses	6
41011060	60 Bardak/Glasses	7,5
41011090	80 Bardak/Glasses	9
41011120	120 Bardak/Glasses	12
41011160	160 Bardak/Glasses	16
41011250	250 Bardak/Glasses	22
41101450	400 Bardak/Glasses	38

» Portakal/Nar Sıkma
Orange/Pomegranate Juicer

Kod Code	Model Model	Koli/Adet Pcs/Ctn
41030002	Portakal/ Orange	1
41030012	Portakal & Nar / Orange & Pomegranate	1



» Buz Kırıcı
Ice Crusher

Kod
Code
63010039



» Buz Kırıcı
Ice Crusher

Kod
Code
63010018



Büyük Özel Buz
Large Special Ice
 Code: LSI
 18 gr

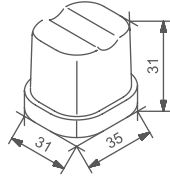

190

frozy®



» Buz Makinesi 25
 Ice Machine 25

Kod
 Code
 72010025

Kapasite (kg / 24h) / Capacity (kg / 24h)	22
Depolama Kapasitesi (kg) / Storage Capacity (kg)	4
Buz Tipi / Ice Type	LSI
Soğutma Sistemi / Cooling System	Air
İklim Sınıfı / Climate Class	T
Soğutucu Gaz / Refrigerant Gas	R134a
Voltaj / Voltage	230V-50Hz
Ölçüler / Dimensions (w x d x h)	355x404x590

frozy®



» Buz Makinesi 35
Ice Machine 35

Kod
Code
72010035

Kapasite / Capacity (kg / 24h)	32
Depolama Kapasitesi (kg) / Storage Capacity (kg)	16
Buz Tipi / Ice Type	LSI
Soğutma Sistemi / Cooling System	Air
İklim Sınıfı / Climate Class	T
Soğutucu Gaz / Refrigerant Gas	R134a
Voltaj / Voltage	230V-50Hz
Ölçüler / Dimensions (w x d x h)	500x580x690

191

frozy®



» Buz Makinesi 50
Ice Machine 50

Kod
Code
72010050

Kapasite / Capacity (kg / 24h)	47
Depolama Kapasitesi (kg) / Storage Capacity (kg)	28
Buz Tipi / Ice Type	LSI
Soğutma Sistemi / Cooling System	Air
İklim Sınıfı / Climate Class	T
Soğutucu Gaz / Refrigerant Gas	R134a
Voltaj / Voltage	230V-50Hz
Ölçüler / Dimensions (w x d x h)	500x580x800



» Vega İçecek Dispenseri
Vega Juice Dispenser

Kod Code	Lt Lt	Koli/Adet Pcs/Ctn
55011412	12	1



» Vega Kahve Dispenseri
Vega Coffee Dispenser

Kod Code	Lt Lt	Koli/Adet Pcs/Ctn
55011312	12	1

192



» Carina İçecek Dispenseri
Carina Juice Dispenser

Kod Code	Lt Lt	Koli/Adet Pcs/Ctn
55011277	7,7	1
55011278	2x7,7	1
55011279	3x7,7	1



» Carina Süt Dispenseri
Carina Milk Dispenser

Kod Code	Lt Lt	Koli/Adet Pcs/Ctn
55011212	6,4	1



» Lux İecek Dispenseri
Lux Juice Dispenser

Kod Code	Lt Lt	Koli/Adet Pcs/Ctn
54012112	12	1



» Lux Kahve Dispenseri
Lux Coffee Dispenser

Kod Code	Lt Lt	Koli/Adet Pcs/Ctn
54012212	12	1



» Meyve Suyu Dispenseri
Juice Dispenser

Kod Code	Ölü (cm) Dim. (cm)	Lt Lt	Koli/Adet Pcs/Ctn
59039021	37x23x60	7	1
59039022	37x45x69	14	1



» Premium İecek Dispenseri
Premium Juice Dispenser

Kod Code	Lt Lt	Koli/Adet Pcs/Ctn
54011112	12	1



» Premium Kahve Dispenseri
Premium Coffee Dispenser

Kod Code	Lt Lt	Koli/Adet Pcs/Ctn
59011019	19	1



» Lux Süt Dispenseri
Lux Milk Can

Kod Code	Lt Lt	Koli/Adet Pcs/Ctn
54011212	6	1

- Kendinden buz hazneli kapak
- Lid has self ice store



» Lux Termos (Switch Kapak)
Beverage Server S/S Insulated

Kod Code	Kapasite (lt) Capacity (lt)	Koli/Adet Pcs/Ctn
51019210	1,00	6
51019215	1,50	6
51019220	2,00	6



» Termos (İç-Dış S/S)
Beverage Server S/S Insulated

Kod Code	Kapasite (lt) Capacity (lt)	Koli/Adet Pcs/Ctn
51021310	1,00	6
51021315	1,50	6
51021320	2,00	6



» Sürahi
Water Jug

Kod Code	Ölçü (cm) Dim. (cm)	Koli/Adet Pcs/Ctn
60011431	Ø 85x26	6



» PC Sürahi
PC Jug

Kod Code	Kapasite (lt) Capacity (lt)	Koli/Adet Pcs/Ctn
60020018	1,8 Lt	6



» French Press
French Press

Kod Code	ml	Koli/Adet Pcs/Ctn
58060350	350	6
58060600	600	6



» İçecek Kupası
Glass Mug

Kod Code	ml	Koli/Adet Pcs/Ctn
59050001	550	12



» Süt Potu
Milk Pot

Kod Code	Model Model	Kapasite (lt) Capacity (lt)	Koli/Adet Pcs/Ctn
62010150	Süt Potu / Milk Pot	150 ml	6



» Mini Tabak
Mini Tea Bag Plate

Kod Code	Model Model	Koli/Adet Pcs/Ctn
40202250	Mini Tabak Mini Tea Bag Plate	1



» Bardak
Mug S/S

Kod Code	Koli/Adet Pcs/Ctn
36702052	12



» Bardak
Glass

Kod Code	ml ml	Ad./Koli Pcs/Ctn
46010250	250	50
46010300	300	50
46010400	400	50



» Kumlu Bardak
Sandy Surface Glass

Kod Code	ml ml	Ad./Koli Pcs/Ctn
46011250	250	400
46011400	400	400



» Prizma/Shot Bardak
Prisma/Shot Glass

Kod Code	ml ml	Model Model	Ad./Koli Pcs/Ctn
46013250	250	Prizma / Prisma	50
46010060	60	Shot / Shot	245

Rakı Bardağı
Juice Glass



Viski Bardağı
Whiskey Glass



» Rakı/Viski Bardağı
Juice/Whiskey Glass

Kod Code	Model Model	ml ml	Ad./Koli Pcs/Ctn
46010240	Rakı/Juice	240	50
46012250	Viski/Whiskey	250	50

Kokteyl Bardağı
Cocktail Glass



Ayklı Bardağı
Goblet Glass



» Ayıklı/Kokteyl Bardak
Goblet/Cocktail Glass

Kod Code	Model Model	ml ml	Ad./Koli Pcs/Ctn
46010295	Ayklı/Goblet	295	50
46010320	Viski/Cocktail	320	50

Şarap Bardağı
Wine Glass



Goblet Bardağı
Goblet Glass



» Sarap Kadehi/Goblet Bardak
Wine/Goblet Glass

Kod Code	Model Model	ml ml	Ad./Koli Pcs/Ctn
46014250	Kadeh/Wine	250	50
46013400	Goblet/Goblet	400	50

Ayran-Bira Bardağı
Beer Glass



Tulip Glass



» Ayran-Bira/Tulip Bardak
Beer/Tulip Glass

Kod Code	Model Model	ml ml	Ad./Koli Pcs/Ctn
46010500	Ayran-Bira/Beer	500	24
46012400	Tulip/Tulip	400	100

460 461



» Çay-Kahve Kupası
Mug

Kod Code	ml ml	Ad./Koli Pcs/Ctn
46015250	250	50
46015300	300	50

460 461 462 463



» Kahve Kupası
Mug

Kod Code	ml ml	Ad./Koli Pcs/Ctn
46010280	280	24

Bar



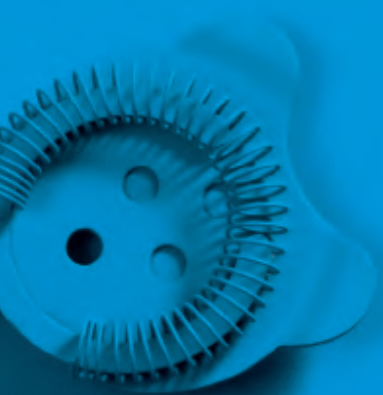

Buz Kovaları & Şişe Soğutucular / Ice Buckets & Bottle Coolers



» Buz Kovası/Mini Punch Kasesi
D/W Ice Bucket/Mini Punch Bowl

Kod Code	Ø (cm) Ø (cm)	Koli/Adet Pcs/Ctn
60030020	20	1

* Çift cidarlıdır.
* Double Wall



» Buz Kovası (Çift Cidarlı)
Ice Bucket (D/W)

Kod Code	Ölçü (cm) Dim. (cm)	Koli/Adet Pcs/Ctn
60016118	Ø15,5x16,5	6



» Buz Kovası Büyük (Çift Cidarlı)
Big Ice Bucket (D/W)

Kod Code	Ölçü (cm) Dim. (cm)	Koli/Adet Pcs/Ctn
60016119	Ø17x20,5	6



» Buz Kovası Halka Saplı Termoslu
Round Handled Ice Bucket

Kod Code	Model Model	Ø (cm) Ø (cm)	Koli/Adet Pcs/Ctn
91000011	Kapaklı/w/Lid	15,5	6
91000012	Kapaklı&Tabaklı w/Lid-Plate	15,5	6



» Buz Kovası Ay Saplı Termoslu
Crescent Handled Ice Bucket

Kod Code	Model Model	Ø (cm) Ø (cm)	Koli/Adet Pcs/Ctn
91000016	Kapaklı/w/Lid	15,4	6
91000015	Kapaklı&Tabaklı w/Lid-Plate	15,4	6

198



» Mat Şişe Soğutucu
D/W Satin Bottle Cooler

Kod Code	Ölçü (mm) Dim. (mm)	Koli/Adet Pcs/Ctn
60016106	Ø12x20	6

* Çift cidarlıdır.
* Double Wall



Şampanya & Şarap Kovaları / Champagne & Wine Buckets



» Halka Saplı Şampanya Kova
Champagne/Wine Bucket

Kod Code	Ölçü (cm) Dim. (cm)	Koli/Adet Pcs/Ctn
36752221	Ø 21x22	6



» Şampanya/Şarap Kova (Mat)
Champagne/Wine Bucket (Satin)

Kod Code	Ölçü (cm) Dim. (cm)	Koli/Adet Pcs/Ctn
60016105	19x21	6



» Şarap Kovası Masa Standı (Çelik)
Wine Bucket Table Stand

Kod Code	Ölçü (cm) Dim. (cm)	Koli/Adet Pcs/Ctn
60010244	50x19x16	6

* Şarap kovası fiyata dahil değildir.
* w/o Bucket

200



» Şişe Standı
Bottle Stand

Kod Code	Ölçü (cm) Dim. (cm)	Koli/Adet Pcs/Ctn
60016141	26x8x14	6



» Punch Kasesi
Punch Bowl

Kod Code	Ölçü (cm) Dim. (cm)	Koli/Adet Pcs/Ctn
60010530	Ø 42x21	1



» Punch Kasesi Lux
Lux Punch Bowl

Kod Code	Ø (cm) Ø (cm)	Koli/Adet Pcs/Ctn
60030037	37,5	1



» Şampanya Kova Standı
Champagne Bucket Stand

Kod Code	Ölçü (cm) Dim. (cm)	Koli/Adet Pcs/Ctn
37752222	65	1



» Ölçü Kabı Cam
Mixing Glass

Kod Code	Koli/Adet Pcs/Ctn
60020008	6



» Klasik Shaker
Cocktail Shaker

Kod Code	ml ml	Koli/Adet Pcs/Ctn
60010350	300	6
60010500	500	6
60010750	750	6



» Boston Shaker S/S
Boston Shaker S/S

Kod Code	Koli/Adet Pcs/Ctn
60020007	6

* Ölçü kabı fiyata dahil değildir.
* w/o Mixing Glass



» Garson Çakısı
Waiter's Corkscrew

Kod Code	Koli/Adet Pcs/Ctn
83010045	6



» Tirbuşon
Winged Corkscrew

Kod Code	Koli/Adet Pcs/Ctn
83010046	6



» Kadeh Tatlandırıcı
Chalice Sweetener

Kod Code	Koli/Adet Pcs/Ctn
60020009	6



» Pepet/Peçetelik
Napkin/Pipette Holder

Kod Code	Koli/Adet Pcs/Ctn
60020012	4



» Bar Matı
Service / Bar Mat

Kod Code	Ölçü (cm) Dim. (cm)	Koli/Adet Pcs/Ctn
62015980	60x80x17	4





» Soda Sifonu
Soda Siphon

Kod Code	Kapasite Capacity	Koli/Adet Pcs/Ctn
43130045	1,0 Lt	1
43130047	10x8 gr Soda Tüpü 10x8 gr Soda Charger	1

* 1 soda tüpü ile 1 litreye kadar soda hazırlanabilir.
* One soda charger will prepare up to 1 litre of soda water.



NEW



» Bar Konteynır
PC Bar Container

Kod Code	Model Model	Koli/Adet Pcs/Ctn
60020004	4 Bölme / 4 Compartment	6
60020005	5 Bölme / 5 Compartment	6
60020006	6 Bölme / 6 Compartment	6

202



» Bar Süzgeci
Bar Strainer

Kod Code	Koli/Adet Pcs/Ctn
62016137	6



» Mojito Tokmagı
Ice Crusher (Mojito)

Kod Code	Koli/Adet Pcs/Ctn
62010031	6



» Bar Kaşığı Dövme Uçlu Twist Saplı
Bar Spoon/Masher (Full Twist)

Kod Code	Ölçü (cm) Dim. (cm)	Koli/Adet Pcs/Ctn
56036222	22	6



» Jigger
Jigger

Kod Code	Kapasite Capacity	Ölçü (cm) Dim. (cm)	Koli/Adet Pcs/Ctn
60016120	2/4 cc	Ø 45x10	6



» Akıtıcı
Pourer S/S

Kod Code	Koli/Adet Pcs/Ctn
62010033	6



» Akıtıcı (PVC)
Pourer (PVC)

Kod Code	Koli/Adet Pcs/Ctn
62010333	6

NEW



» Üçlü Çerezlik
Triple Nuts Display

Kod Code	Ölçü (cm) Dim. (cm)	Koli/Adet Pcs/Ctn
39311000	6,5	1
39311001	8	1
39311002	9	1
40310013	10	1



» Bölmeli Sosluk/Çerezlik
Partitioned Nuts Bowl

Kod Code	Model Model	Ölçü (cm) Dim. (cm)	Koli/Adet Pcs/Ctn
80010195	2 Bölmeli / 2 Partitioned	10x17,5x2,5	12
80010196	3 Bölmeli / 3 Partitioned	10x26x2,7	12
80010197	4 Bölmeli / 4 Partitioned	10x33x2,5	12



203



» 2 Bölmeli Dikdörtgen Çerezlik
2 Part. Rectangular Nuts Bowl

Kod Code	Ölçü (cm) Dim. (cm)	Koli/Adet Pcs/Ctn
80010001	13x24x4	24



» 2 Bölmeli Yuvarlak Çerezlik
2 Partitioned Round Nuts Bowl

Kod Code	Ölçü (cm) Dim. (cm)	Koli/Adet Pcs/Ctn
80010002	10x20x5,5	36



» 3 Bölmeli Oval Çerezlik
3 Partitioned Oval Nuts Bowl

Kod Code	Ölçü (cm) Dim. (cm)	Koli/Adet Pcs/Ctn
80010003	16,5x24x4	24



» 3 Bölmeli Yuvarlak Çerezlik
3 Partitioned Round Nuts Bowl

Kod Code	Ölçü (cm) Dim. (cm)	Koli/Adet Pcs/Ctn
80010004	25,5x25,5x3	24

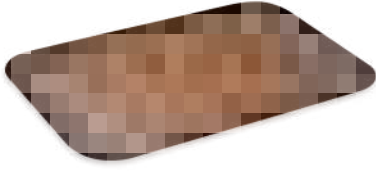

» Ecoform Tepsi
Ecoform Rectangular Tray

Kod Code	Ölçü (cm) Dim. (cm)	Koli/Adet Pcs/Ctn
68313753	37x53	1



» Maun Dikdörtgen Tepsi
Wooden Rectangular Tray

Kod Code	Ölçü (cm) Dim. (cm)	Koli/Adet Pcs/Ctn
68012738	27x38	1
68013244	32x44	1
68013646	36x46	1
68013753	37x53	1
68014361	43x61	1



» Kırçillı Tepsi
Textured Tray

Kod Code	Ölçü (cm) Dim. (cm)	Koli/Adet Pcs/Ctn
46612736	27x36	1
46613244	32x44	1
46613646	36x46	1
46613748	37x48	1
46613753	37x53	1



» Fiber Kaydırmaz Yuvarlak Tepsi
Fiber Non-slip Round Tray

Kod Code	Ø (cm) Ø (cm)	Koli/Adet Pcs/Ctn
68210035	35,5	1
68210040	40,6	1
68210045	45	1



» Maun Kaydırmaz Yuvarlak Tepsi
Wooden Non-slip Round Tray

Kod Code	Ø (cm) Ø (cm)	Koli/Adet Pcs/Ctn
68110033	33	1
68110038	38	1
68110043	43	1

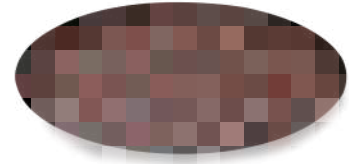

» Maun Yuvarlak Tepsi
Wooden Round Tray

Kod Code	Ø (cm) Ø (cm)	Koli/Adet Pcs/Ctn
68010033	33	1
68010038	38	1
68010043	43	1



» Fiber Kaydırmaz Dikdörtgen Tepsi
Fiber Non-slip Rectangular Tray

Kod Code	Ölçü (cm) Dim. (cm)	Koli/Adet Pcs/Ctn
68213040	30x40	1
68213753	37x53	1
68214565	45x65	1
68215668	56x68	1

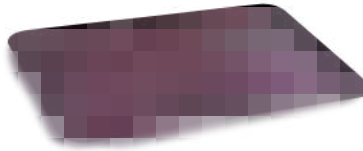

» Maun Kaydırmaz Dikdörtgen Tepsi
Wooden Non-slip Rectangular Tray

Kod Code	Ölçü (cm) Dim. (cm)	Koli/Adet Pcs/Ctn
68112738	27x38	1
68113244	32x44	1
68113646	36x46	1
68113753	37x53	1
68114361	43x61	1



» Ecoform Kaydırmaz Tepsi
Ecoform Non-slip Rectangular Tray

Kod Code	Ölçü (cm) Dim. (cm)	Koli/Adet Pcs/Ctn
68413753	37x53	1



» Döküm
Casted Black Ashtray

Kod Code	Model Model	Ölçü (cm) Dim. (cm)	Koli/Adet Pcs/Ctn
43040004	Kare/ Square	8x8x3,5	1
43040005	Yuvarlak Round	Ø 9,3x4	1



» Döküm
Casted Ashtray

Kod Code	Model Model	Ölçü (cm) Dim. (cm)	Koli/Adet Pcs/Ctn
40350013	Kare/ Square	8x8x3,5	1
43040001	Yuvarlak Round	Ø 9,3x4	1



» Döküm Bronz
Casted Bronze Ashtray

Kod Code	Model Model	Ölçü (cm) Dim. (cm)	Koli/Adet Pcs/Ctn
43040002	Kare/ Square	8x8x3,5	1
43040003	Yuvarlak Round	Ø 9,3x4	1



» Ayaklı Küllük Stand
Ashtray Stand

Kod Code	h (cm) h (cm)	Koli/Adet Pcs/Ctn
40010004	76	1



» Kare Havuzlu
Square Ashtray w/Cover

Kod Code	Koli/Adet Pcs/Ctn
35930000	1



» Yuvarlak Havuzlu
Round Ashtray w/Cover

Kod Code	Koli/Adet Pcs/Ctn
35940000	1



» Havuzlu Rüzgarlıkl
Wind Protected Ashtray

Kod Code	Model Model	Koli/Adet Pcs/Ctn
43040011	Küçük / Small	1
43040010	Büyük / Big	1

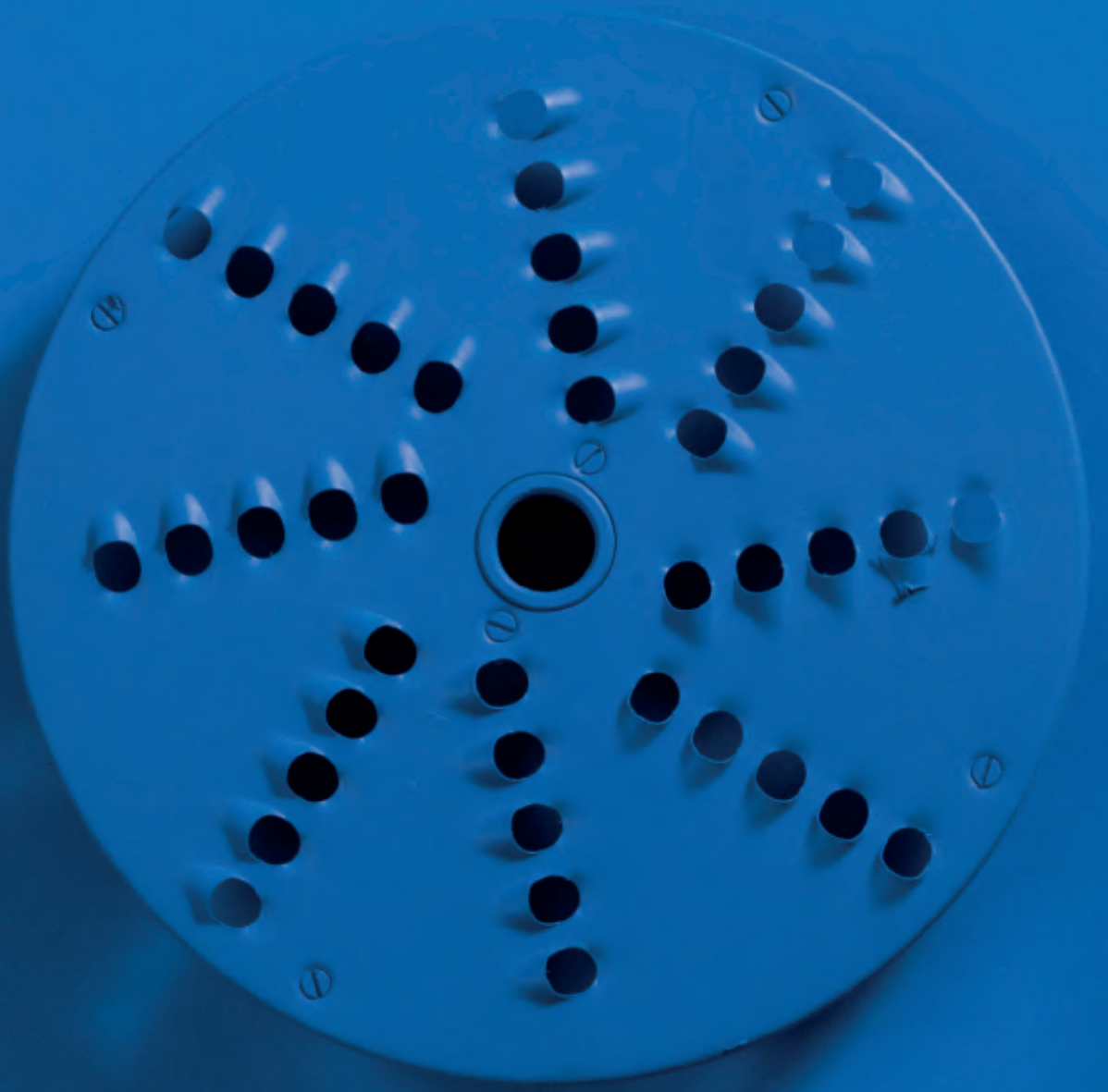

Ekipmanlar/Kitchen Appliances



- Yüksek verimli patentli soğutma sistemli motor
- Sağlam ve hafif fiberglass ABS gövde
- Yüksek verimli motorlar
- 3 farklı hız kontrolü
- Matkap sistemli hız kontrolü
- Sabitlenebilir hız kontrolü
- Cihazın yanlışlıkla açılmasını önleyen güvenlik mekanizması
- Sürekli karıştırma için tetik sistemli mandal
- 3 farklı motor
- IPX3 su geçirmezlik koruması
- Pratik montaj mekanizması
- Daha uzun ömür ve doğru temizlik için tamamen ayrılabilir miler
- Efficient engine cooling system
- Sturdy, lightweight ABS frame Glass Filled
- Practical and ergonomic handle
- Powerful performance engines
- Fixed speed
- Variotronic: speed control with stabilizer
- Safety system against accidental ignition
- The Trigger switch
- Available in 3 different engines
- The machine is protected with IPX3
- Quick coupling system
- Totally removable rods for a thorough cleaning which extends their life

Soğutmalı Motor
Ventilated Motor

208

» Kod
CodeModel
Model63010042
63010023
63010008
63010009
63010024El Tipi Blender / Blender
Şaft 35 cm / Shaft 35 cm
Şaft 45 cm / Shaft 45 cm
Çırpıcı / Whisk
Duvar Askısı / Wall Attachment

63010042

El Tipi Blender
Blender

63010008

63010023

63010009

Çırpıcı ve Saftlar
Whisk and Shaft

63010024

Duvar Askısı
Wall Attachment

Güç / Power

750 W

Güç Kaynağı / Power Source

230 V/50 Hz

Bıçak Deviri / Knives Revolutions

r.p.m. 2000 - 11:500

Çalışma Kapasitesi / Working Capacity

300 Lt

Net Ağırlık / Net Weight

3,9 Kg

Ölçüler / Dimensions

A	B	C
125 mm	190 mm	390 mm

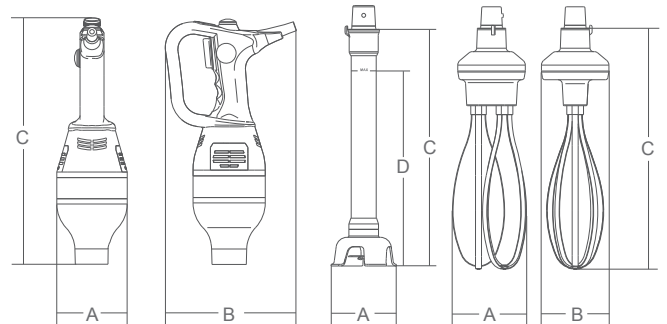

Made in Italy

- Yüksek verimli patentli soğutma sistemli motor
- Sağlam ve hafif fiberglass ABS gövde
- Yüksek verimli motorlar
- 3 farklı hız kontrolü
- Matkap sistemli hız kontrolü
- Sabitlenebilir hız kontrolü
- Cihazın yanlışlıkla açılmasını önleyen güvenlik mekanizması
- Sürekli karıştırma için tetik sistemli mandal
- 3 farklı motor
- IPX3 su geçirmezlik koruması
- Pratik montaj mekanizması
- Daha uzun ömür ve doğru temizlik için tamamen ayrılabilir miler
- Efficient engine cooling system
- Sturdy, lightweight ABS frame Glass Filled
- Practical and ergonomic handle
- Powerful performance engines
- Fixed speed
- Variotronic: speed control with stabilizer
- Safety system against accidental ignition
- The Trigger switch
- Available in 3 different engines
- The machine is protected with IPX3
- Quick coupling system
- Totally removable rods for a thorough cleaning which extends their life

 Soğutmalı Motor
Ventilated Motor

 >> Kod
Code

 Model
Model

 63010006
63010023
63010008
63010009
63010024

 El Tipi Blender / Blender
Şaft 35 cm / Shaft 35 cm
Şaft 45 cm / Shaft 45 cm
Çırpıcı / Whisk
Duvar Askısı / Wall Attachment

209



63010006



63010024

Güç / Power

550 W

Güç Kaynağı / Power Source

230 V/50 Hz

Bıçak Deviri / Knives Revolutions

r.p.m. 13.000

Çalışma Kapasitesi / Working Capacity

200 Lt

Net Ağırlık / Net Weight

3,5 Kg

Ölçüler / Dimensions

A	B	C
125 mm	190 mm	385 mm

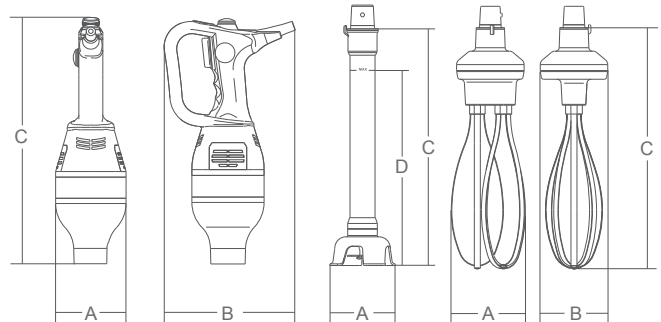



Made in Italy

- Yüksek verimli patentli soğutma sistemli motor
 - Sağlam ve hafif fiberglass ABS gövde
 - Matkap sistemli hız kontrolü
 - Sabitlenebilir hız kontrolü
 - Cihazın yanlışlıkla açılmasını önleyen güvenlik mekanizması
 - Sürekli karıştırma için tetik sistemli mandal
 - IPX3 su geçirmezlik koruması
 - Pratik montaj mekanizması
 - Daha uzun ömür ve doğru temizlik için tamamen ayrılabilir miler
 - Paslanmaz çelik mil ve kampana
- Efficient engine cooling system
 - Sturdy, lightweight ABS frame Glass Filled
 - Fixed and variable speed controls available
 - Safety system against accidental ignition
 - The Trigger switch
 - The machine is protected with IPX3
 - Quick coupling system
 - Cutlery steel knives
 - Whisk with metal gearing
 - Whips Demountable and in the dishwasher

 Soğutmalı Motor
Ventilated Motor



Kod Code	Model Model
63010043	El Tipi Blender / Blender
63010044	Şaft 35 cm / Shaft 35 cm
63010045	Şaft 45 cm / Shaft 45 cm
63010046	Çırpıcı / Whisk
63010024	Duvar Askısı / Wall Attachment

211

63010043

 El Tipi Blender
Blender

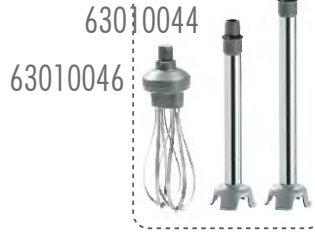
63010045

 Çırpıcı ve Saftlar
Whisk and Shaft

63010024

 Duvar Askısı
Wall Attachment

Güç / Power	360 W
Güç Kaynağı / Power Source	230 V/50 Hz
Bıçak Deviri / Knives Revolutions	r.p.m. 12.000
Çalışma Kapasitesi / Working Capacity	70 Lt
Net Ağırlık / Net Weight	2,5 Kg
Ölçüler / Dimensions	A B C
	100 mm 182 mm 348 mm

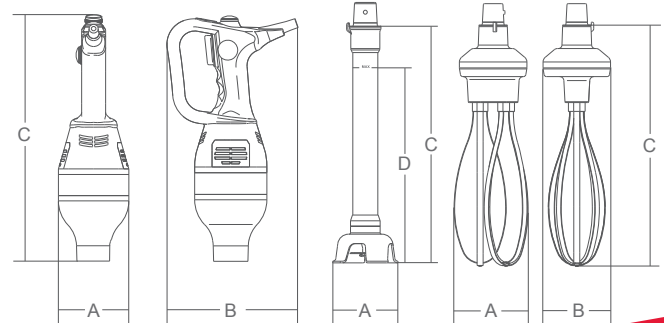

- Alüminyum alaşım ve paslanmaz çelik gövde
- Kesintisiz çalışma için soğutmalı motor
- Az yer kaplayan tasarımı sayesinde her mutfakta kolay kurulum
- Ayrıcıklı besleme sistemi sayesinde yumuşak ürünleri işleme kolaylığı
- Besleme kolu, kapak ve toplama kabı arasındaki bağlantılı kilit sistemi sayesinde güvenli kullanım
- Her amaca uygun çok sayıda bıçak çeşidi (isteğe bağlı)

- Aluminium alloy and S/S construction.
- Ventilated motor for continuous operation.
- Thanks to its compact design the machine is easy to install inside every kitchen.
- The exclusive feeding system makes easy to process also soft products like moz-zarella cheese.
- Safe operation is ensured by interlock switches on product pusher, lid and collect-ing tray.
- Version with dishwashing safe S/S lid available
- Large number of discs available for every purpose



212

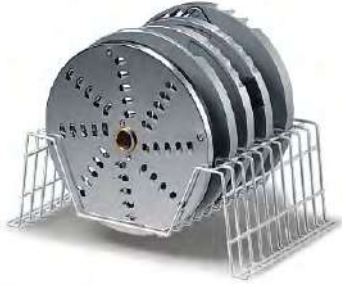

Disk Tutucu
Disc Holder

» Kod
Code
63010001
63010002

Model
Model
Sebze Doğrayıcı
Vegetable Cutter
Disk Tutucu
Disc Holder



Güç / Power

515 W

Güç Kaynağı / Power Source

230-400 V

Disk Deviri / Disc Revolutions

r.p.m. 300

Net Ağırlık / Net Weight

17,5 Kg

Ölçüler / Dimensions

A B C D E G H
225 mm 195 mm 255 mm 280 mm 510 mm 510 mm 770 mm

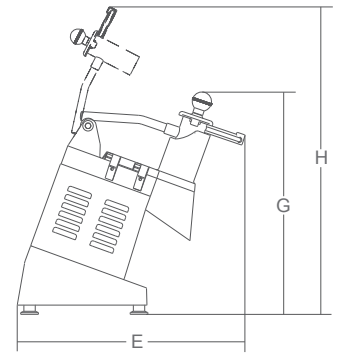
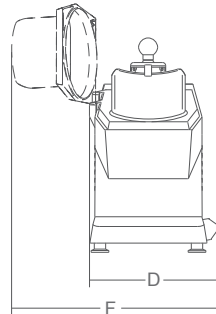
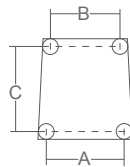



Dilimleyici Bıçaklar
Slicer Discs

* DF5 domates dilimleme için tavsiye edilir.
* DF5 is recommended for tomato slicing.

Kod Code	Kesme Kalınlığı (mm) Cutting Thickness (mm)
DF14	14
DF10	10
DF8	8
DF3	3
DF4	4
DF1	1
DF2	2
DF5*	5

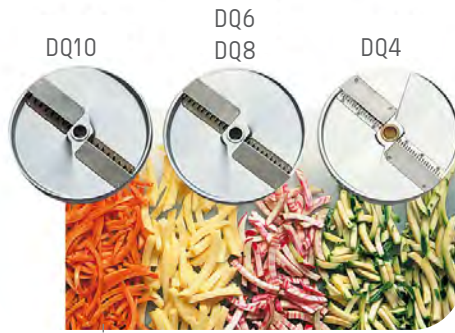

Jülyen Dilimleyici Bıçaklar
Jullien Slicer Discs

Kod Code	Kesme Kalınlığı (mm) Cutting Thickness (mm)
DQ10	10
DQ8	8
DQ6	6
DQ4	4

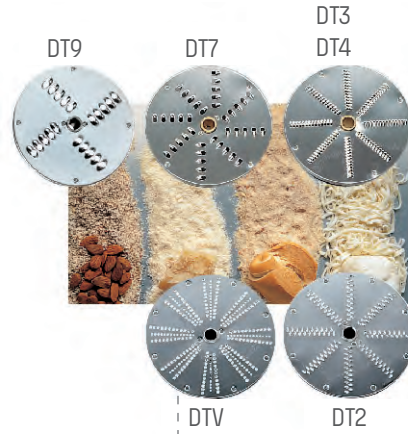

Rendeleyici ve Ufalayıcı Bıçaklar
Grater and Granulator Discs

Kod Code	Kesme Kalınlığı (mm) Cutting Thickness (mm)
DT9	9
DT7	7
DT4	4
DT3	3
DT2	2
DTV	1



Küp Doğrayıcı Bıçaklar
Dicer Discs

Kod Code	Kesme Kalınlığı (mm) Cutting Thickness (mm)
PS14	14
PS10	10
PS8	8

- Güçlü AISI 430 çelik gövde
- Daha iyi ısı yalıtımı için bağımsız motor ve kase
- Kalın tabanlı ve saplı paslanmaz kase
- Sürekli işleme uygun yüksek etkili soğutmalı motor
- Güçlü çelik bıçaklar
- Kapak üzerinde güvenli işletimi sağlayan mikro anahtarlar
- Şeffaf lexan kapak
- Sabitleyici hız kontrolü
- İşletim sırasında malzeme eklemeye uygun açılabilen kapak
- Kademesiz değişken hız sürücü
- Spatula ve bilek taşı dahildir
- Strong AISI 430 steel construction
- Detached motor and bowl for a better thermal insulation
- S/S bowl with handles and heavy bottom
- High efficiency ventilated motor for continuous operation
- Strong cutlery steel knives
- Safe operations ensured by a system of micro switches on the lid
- See-through lexan lid
- Variotronic: speed control with stabilizer
- Lid with opening to add ingredients during operation



Sogutmalı Motor
Ventilated Motor

>> Kod
Code

Model
Model

63010004
63020004
63030004
63040004

Sebze Doğrayıcı / Vegetable Cutter
Emülsiyon Bıçağı / Emulsifying Knife
Dişli Bıçak / Serrated Knife
Pesto Bıçağı (4 bıçaklı) / Shaft w/knives for pesto sauce

* Standart bıçak fiyata dahildir.
* Incl/Standard blade



Standart bıçak
Standard knife

214

63020004



Emülsiyon Bıçağı
Emulsifying Knife

63030004



Dişli Bıçak
Serrated Knife

63040004



Pesto sosu için 4 bıçaklı shaft
Shaft w/knives for pesto sauce

Güç / Power

350 W

Hazne Kapasitesi / Bowl Capacity

3,3 Lt

Hazne Dolma Seviyesi / Bowl Filling Level

1,5 Lt

Devir / Revolutions

r.p.m. 2.800

Net Ağırlık / Net Weight

10 Kg

Ölçüler / Dimensions

A B C D E
160 mm 310 mm 305 mm 365 mm 255 mm

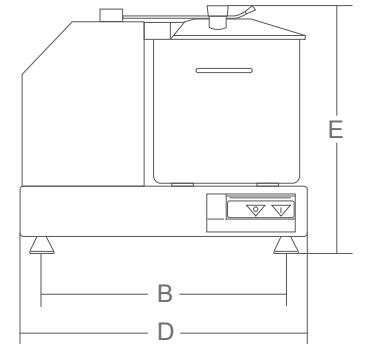
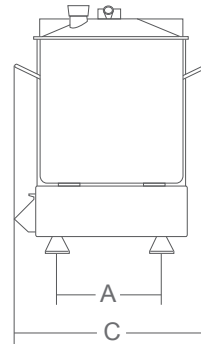

Made in Italy

- Güçlü AISI 430 çelik gövde
- Daha iyi ısı yalıtımı için bağımsız motor ve kase
- Kalın tabanlı ve saplı paslanmaz kase
- Sürekli işleme uygun yüksek etkili soğutmalı motor
- Güçlü çelik bıçaklar
- Kapak üzerinde güvenli işletimi sağlayan mikro anahtarlar
- Şeffaf lexan kapak
- Sabitleyici hız kontrolü
- İşletim sırasında malzeme eklemeye uygun açılabilen kapak
- Kademesiz değişken hız sürücü
- Spatula ve bilek taşı dahildir
- Strong AISI 430 steel construction
- Detached motor and bowl for a better thermal insulation
- S/S bowl with handles and heavy bottom
- High efficiency ventilated motor for continuous operation
- Strong cutlery steel knives
- Safe operations ensured by a system of micro switches on the lid
- See-through lexan lid
- Variotronic: speed control with stabilizer
- Lid with opening to add ingredients during operation

 Soğutmalı Motor
Ventilated Motor

 >> Kod
Code

 63010005
63020005
63030005
63040005

 Model
Model

 Sebze Doğrayıcı / Vegetable Cutter
Emülsiyon Bıçağı / Emulsifying Knife
Dişli Bıçak / Serrated Knife
Pesto Bıçağı (4 bıçaklı) / Shaft w/knives for pesto sauce
* Standart bıçak fiyata dahildir.
* Incl/Standard blade

 Standart bıçak
Standard knife

215

63020004

 Emülsiyon Bıçağı
Emulsifying Knife

63030004

 Dişli Bıçak
Serrated Knife

63040004

 Pesto sosu için 4 bıçaklı shaft
Shaft w/knives for pesto sauce

Güç / Power

350 W

Hazne Kapasitesi / Bowl Capacity

5,3 Lt

Hazne Dolma Seviyesi / Bowl Filling Level

3,1 Lt

Devir / Revolutions

r.p.m. 1.500+2.800

Net Ağırlık / Net Weight

11 Kg

Ölçüler / Dimensions

A	B	C	D	E
160 mm	310 mm	305 mm	365 mm	320 mm

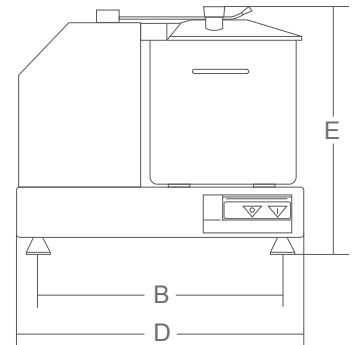
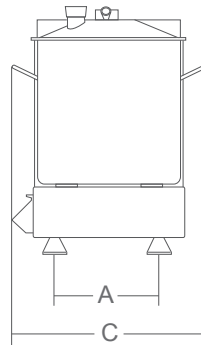

- Güçlü AISI 430 çelik gövde
- Daha iyi ısı yalıtımı için bağımsız motor ve kase
- Kalın tabanlı ve saplı paslanmaz kase
- Sürekli işleme uygun yüksek etkili soğutmalı motor
- Güçlü çelik bıçaklar
- Kapak üzerinde güvenli işlemini sağlayan mikro anahtarlar
- Şeffaf lexan kapak
- Sabitleyici hız kontrolü
- Base-plate and reservoir in heat-resistant ABS
- Lid in PC with hole to add the ingredients during processing
- Interlocked lid and reservoir, easy to disassemble though for cleaning
- Motor brake
- Control with NVR 24 Volt IP 67
- Included items:
- Hub with cutting knives in stainless steel
- Hub for ABS assembly
- Dismountable scraping blade



Sogutmalı Motor
Ventilated Motor

» Kod
Code

63010003
63030006

Model
Model

Sebze Doğrayıcı / Vegetable Cutter
Temizleme Bıçağı / Board Scraper

* Bıçaklar fiyata dahildir.

* Knives included

216



Temizleme Bıçağı
Board Scraper



Hamur karıştırıcı bıçaklı shaft
Shaft w/knives to mix dough

Güç / Power

350 W

Hazne Kapasitesi / Bowl Capacity

3,3 Lt

Hazne Dolma Seviyesi / Bowl Filling Level

1,5 Lt

Devir / Revolutions

r.p.m. 2.800

Net Ağırlık / Net Weight

10 Kg

Ölçüler / Dimensions

A B C D E
160 mm 310 mm 305 mm 365 mm 255 mm

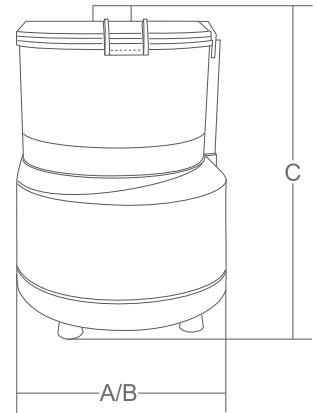

- Yüksek performans ve çalışma kapasiteli, tek parça dayanıklı cihaz
- Peyniri ve ekmeği aynı oranda ve ziyan etmeden rendeleme olanağı
- Cilalanmış alüminyum gövde, işlenmiş paslanmaz çelik silindir
- Strong machine, simple and compact, gives a high performance and power.
- It offers thr possibility of grating cheese and bread with uniformity and without any waste.
- Structure realised in polished aluminium, treated steel roller anti-corrosive.



» Kod
Code

63010021

Model
Model

Peynir rendeleyici / Cheese Grater

217



Muhafazalı Rende / Paslanmaz çelik silindir
Protection grater / Stainless steel drum



Rende üzerinde mikro anahtarı
Microswitch on the grater

Güç / Power

588 W

Güç Kaynağı / Power Source

230 - 400 V/50-60 Hz F+N

Silindir Devri / Drum Revolutions

r.p.m. 1400

Giriş Ebatı / Mouth Revolutions

130 x 70

Net Ağırlık / Net Weight

16 Kg

Ölçüler / Dimensions

A B C D E F
185 mm 270 mm 290 mm 390 mm 370 mm 560 mm

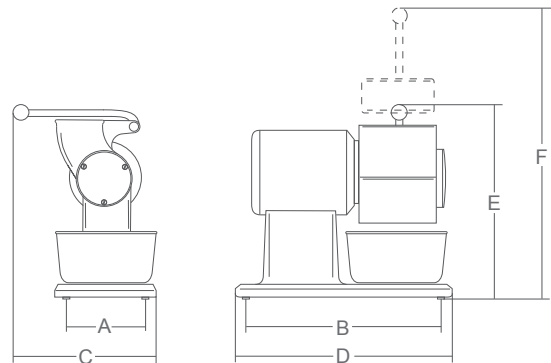

- Boyalı alüminyum gövde
- Döküm alüminyum parçalar
- Kolay temizlemeye uygun bıçak-motor aralığı
- Soğutmalı motor
- Hassas kalınlık ayarı desteği
- Kendi üzerine monteli bileyici düzenegi
- Küçük boyutlar ve yüksek kesme kapasitesi
- 25° bıçak eğim
- Anodized cast aluminium alloy
- Great distance between blade and motor for easy cleaning
- Ventilated motor
- Forged, hardened large thickness blades
- Strong thickness gauge support
- Cast-in sharpener assembly
- Compact dimensions and great cutting capacity
- CE professional with device for releasing the carriage
- 25° blade inclination



250

Soğutmalı Motor
Ventilated Motor

218

» Kod
Code
63010250Model
Model
Dilimleyici 250 / Slicer 250

Bıçak / Blade	Ø 250 mm
Motor / Motor	147 W / 0,20 Hp
Kesme Kalınlığı / Cut Thickness	13 mm
Hareket Mesafesi / Run of Carriage	245 mm
Hazne / Hopper	230 x 230 mm
Kesim Kapasitesi / Cut Capacity	215 x 180

Ölçüler / Dimensions

A	B	C	D	E	F	G	L
395 mm	245 mm	500 mm	560 mm	370 mm	570 mm	475 mm	490 mm

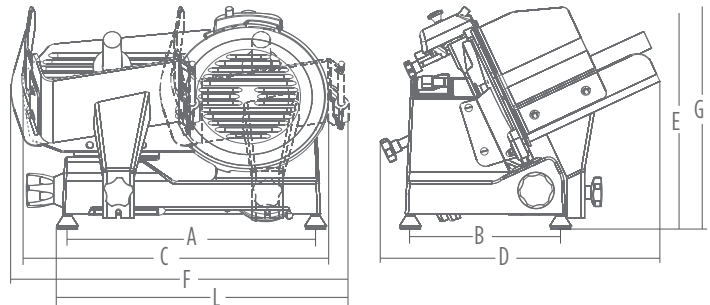

- Eloksoallı alüminyum alaşım gövde
- Kolay temizlemeye uygun bıçak-motor aralığı
- Soğutmalı motor
- Güçlendirilmiş ve sertleştirilmiş kalınlık ayar bıçakları
- Kendinden yağlamalı mil yatağı
- Hassas kalınlık ayarlama kolu
- Yüksek kesim kapasitesi
- 25° bıçak eğimi
- Anodized cast aluminium alloy
- Great distance between blade and motor for easy cleaning
- Ventilated motor
- Forged, hardened large thickness blades
- Strong thickness gauge support
- Cast-in sharpener assembly
- Compact dimensions and great cutting capacity
- CE professional with device for releasing the carriage
- 25° blade inclination

**250**Soğutmalı Motor
Ventilated Motor» Kod
Code

63010026

Model
Model

Dilimleyici 250 / Slicer 250

219

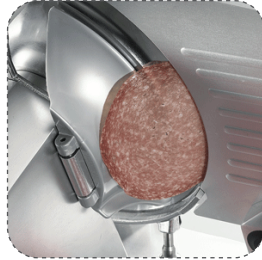

Bıçak / Blade

Ø 250 mm

Motor / Motor

147 W / 0,20 Hp

Kesme Kalınlığı / Cut Thickness

13 mm

Hareket Mesafesi / Run of Carriage

245 mm

Hazne / Hopper

230 x 230 mm

Kesim Kapasitesi / Cut Capacity

215 x 180

Ölçüler / Dimensions

A	B	C	D	E	F	G
395 mm	245 mm	500 mm	560 mm	370 mm	570 mm	475 mm

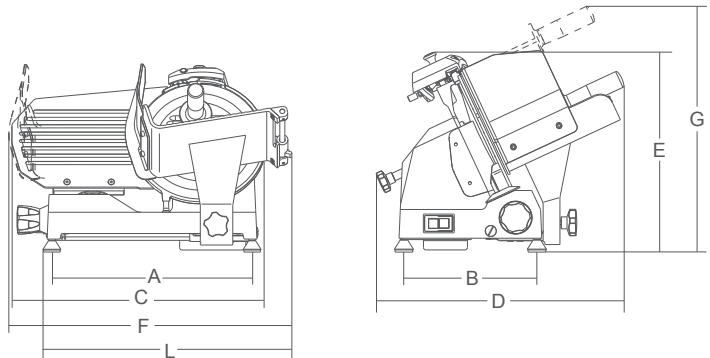

- Elokssallı döküm alüminyum gövde
 - Kolay temizlemeye uygun bıçak - motor aralığı
 - Soğutmalı motor
 - Güçlendirilmiş, kalın dövme bıçaklar
 - Kendinden yağlamalı mil yatağı ve üst üste bindirilmiş pim üzerinde çalışan hareketli parça
 - Hassas kalınlık ayarı desteği
 - Küçük boyutlar ve yüksek kesme kapasitesi
 - 25° bıçak eğimi
- Anodized cast aluminium alloy
 - Great distance between blade and motor for easy cleaning
 - Ventilated motor
 - Forged, hardened large thickness blades
 - Strong thickness gauge support
 - Cast-in sharpener assembly
 - Compact dimensions and great cutting capacity
 - CE professional with device for releasing the carriage
 - 25° blade inclination



300

Soğutmalı Motor
Ventilated Motor

220

» Kod
Code

63010300

Model
Model

Dilimleyici 300 / Slicer 300

Hareketli parçayı ayıran mekanizma
Device for releasing tre carriageKolay temizlemeye uygun bıçak - motor aralığı
More space between blade and body machineKapalı ve sızdırmaz kayış kasağı
Enclosed and sealed belt pulley standard

Bıçak / Blade

Ø 300 mm

Motor / Motor

210 W

Kesme Kalınlığı / Cut Thickness

13 mm

Hareket Mesafesi / Run of Carriage

285 mm

Hazne / Hopper

250x275 mm

Kesim Kapasitesi / Cut Capacity

20,5 Kg

Ölçüler / Dimensions

A	B	C	D	E	F	G	L
435 mm	295 mm	600 mm	610 mm	420 mm	640 mm	510 mm	535 mm

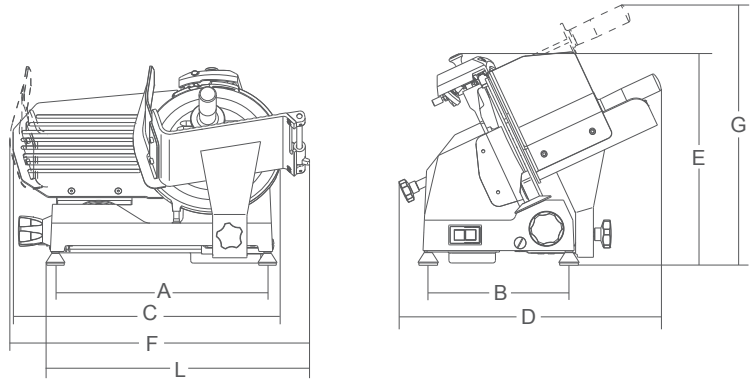

Made in Italy

- Kösesiz, yuvarlak dizayn
- Hareketli parça üzerinde sertleştirilmiş kauçuk durdurucular
- Kapalı ve sızdırmaz kayış kasağı
- Motor ve bıçak arasında 49,5 mm mesafe
- Taban kapağı
- 110- 220- 380 V değiştirilebilir tek ve üç aşamalı elektronik devir
- Taban korumalı gömme bileyici
- Bıçak çıkartma aparatı
- 35° bıçak eğimi
- IP67 koruma seviyeli plastik basma düğmeleri
- Rounded design, no sharp edges and visible screws
- Vulcanized rubber stops on carriage
- Removable support cover for thickness gauge plate
- Enclosed and sealed belt pulley
- 49,5 mm distance between blade and motor
- Bottom cover
- Changeover electronic circuit 110-220-380 V single and three phase
- Built in sharpening tool with bottom protection
- Standard blade removal tool
- 35° blade inclination
- Plastic pushbuttons with IP67 protection rating

 Soğutmalı Motor
Ventilated Motor

350

221

 >> Kod
Code
63010350

 Model
Model
Dilimleyici 350 / Slicer 350

 Bıçak ve gövde arasında daha fazla mesafe
More space between blade and body machine

 Geniş Hazne
Large hopper

Bıçak / Blade	Ø 350 mm
Motor / Motor	370 W
Kesme Kalınlığı / Cut Thickness	23 mm
Hareket Mesafesi / Run of Carriage	310 mm
Hazne / Hopper	305x270 mm
Kesim Kapasitesi / Cut Capacity	46 Kg
Ölçüler / Dimensions	

A	B	C	D	E	F	G	L
465 mm	340 mm	660 mm	575 mm	455 mm	710 mm	530 mm	590 mm

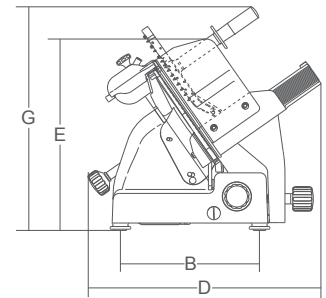
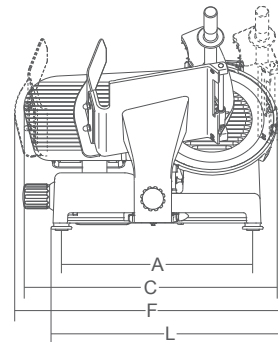



- Köşesiz, yuvarlak dizayn
- Motor ve bıçak arasında 48 mm mesafe
- Krom kaplamalı, kayar mil
- Hareketli parça üzerinde sertleştirilmiş kauçuk durdurucular
- Kalınlık ayar bıçağı üzerinde çıkarılabilir koruma kapağı
- Elektrik aksamına erişimi engelleyen alt kapak
- Taban korumalı dahili bileyici
- Bıçak çıkartma aparatı
- IP67 koruma seviyeli plastik düğmeler
- Rounded design and no sharp edges or visible screws
- Chrome plated ground and lapped slide rod
- Vulcanised rubber stops on carriage
- Removable support cover for thickness gauge plate
- Bottom cover for accessing electrical Components
- Built-in sharpening tool with bottom protection
- Easy to remove grease guard mounted along the thickness gauge plate
- Standard blade removal tool
- Plastic pushbuttons with IP67 protection rating



Dik Tip Vertical

Soğutmalı Motor
Ventilated Motor

>> Kod
Code
63010027

Model
Model
Dik Tip Dilimleyici / Vertical Slicer

223



Bıçak / Blade

Motor / Motor

Kesme Kalınlığı / Cut Thickness

Hareket Mesafesi / Run of Carriage

Hazne / Hopper

Kesim Kapasitesi / Cut Capacity

Ölçüler / Dimensions

Ø 350 mm

370 W / 0,50 Hp

29 mm

310 mm

300 x 270 mm

215 x 180

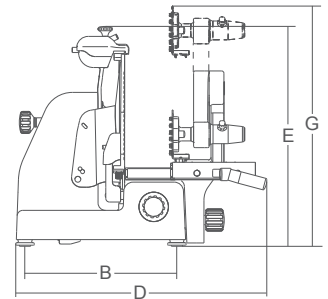
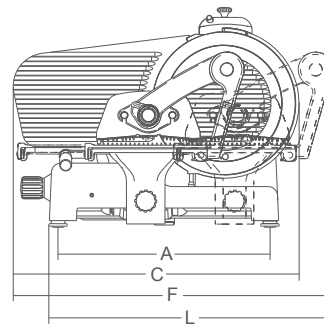

A B C D E F G L
468 mm 338 mm 660 mm 600 mm 530 mm 750 mm 715 mm 630 mm

- Metal Döküm planet mikser
- Kaldırılabilir üst parça sayesinde çıkabilir hazne ve ekipmanlar, kolay temizlik
- Çıkarılabilir 7 lt paslanmaz çelik kase
- 3 adet metal aparat
- Hız kontrollü D.C. motor
- Üst gövde de güvenlik kilidi
- NVR cihazı
- Orta yoğunluklu karışım için uygundur
- Yüksek yoğunluklu karışım için uygun değildir
- Metal cast planetary mixer
- Lifiable head for bowl and tools removal and easy cleaning
- Removable, S/S, 7L bowl
- 3 metal tools
- D.C. motor with speed control
- Safety microswitch on the head
- NVR device
- Suitable for medium density mix (for ex. Bread dough, about 1 kg of flour)
- NOT suitable for tough mix



7 Lt

224

» Kod
Code

63010007

Model
Model

Planet Mikser 7 Lt / Planet Mixer 7 Lt

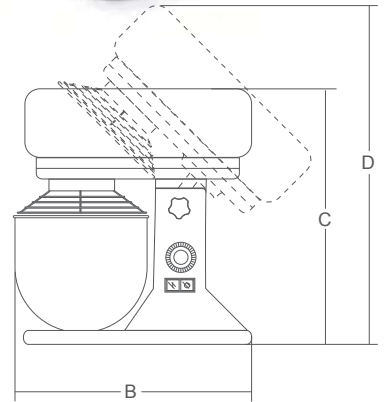
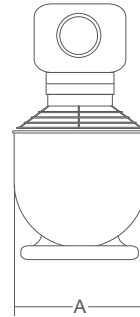

Güç / Power

280 W

Güç Kaynağı / Power Source

230 V/50 Hz

Çırpma Devri / Whisk Revolutions

g./75+660

Hazne Kapasitesi / Bowl Capacity

7 Lt

Net Ağırlık / Net Weight

18 Kg

Ölçüler / Dimensions

A	B	C	D
240 mm	410 mm	425 mm	540 mm

- Yüksek kalınlıkta toz boya kaplı çelik gövde
- Metal ızgara korumalı hazne
- Kolay çıkarılabilir 304 paslanmaz çelik hazne
- Hazne ve kapak için güvenlik kilidi
- Çıkarılabilir 3 metal parça: alüminyum spatula, kanca, çelik ve alüminyum çırpıcı
- 3 hız kademesi
- Çelik şanzıman kutusu
- Soğutmalı motor

- Machine body made from large thickness powder coated steel
- Bowl protection made from metal wire
- Easy to remove bowl made from stainless steel 304
- Safety microswitches for the lid and the bowl
- 3 easy to remove metal tools: aluminium spatula and hook, steel and aluminium whisk
- 3 speed gear
- Steel gear box
- Ventilated motor



10 Lt

Minneapolis

225

» Kod
Code

63010010

Model
Model

Planet Mikser 10 Lt / Planet Mixer 10 Lt

Güç / Power

450 W

Güç Kaynağı / Power Source

230 V/50 Hz

Çırpma Devri / Whisk Revolutions

108/195/355 r.p.m.

Hazne Kapasitesi / Bowl Capacity

10 Lt

Net Ağırlık / Net Weight

74 Kg

Ölçüler / Dimensions

A	B	C	D	E
360 mm	345 mm	440 mm	500 mm	630 mm

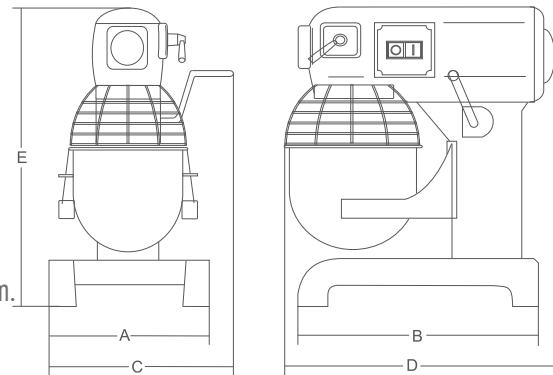

- Tezgah üstü model; Hijyenik ve paslanmaz polisajlı eloksallı alüminyum gövde
- Paslanmaz çelik kesim tablası, et itici ve et dilimleyici
- Kemik veya et kesmeye uygun 16 mm, geniş, güçlendirilmiş bıçaklar (donmuş ve taze)
- Kapı üzeri ve motor fren mikroswitchi (yeni CE güvenlik kurallarına göre)
- 24V emniyetli kontrol
- Makaraların yarı bükülmüş şekli sayesinde mükemmel bıçak-makara tutuşu
- Yağ keçesi ile korunan 4 kutuplu eşzamansız ve soğutmalı motor
- Güvenli ve kolay kullanım
- Table-top model; cast anodizedaluminium alloy construction, polished, hygienic and rustproof
- Cutting table, meat pusher and meat pusher in stainless steel AISI 304
- 24V controls with safety codified microswitches on the door and motor brake (according to new CE safety rules)
- Powerful asynchronous and ventilated 4-pole motors protected by sealing oil ring
- 16 mm wide tempered ring-blades useful for cutting bones or meat (frozen or fresh)
- Simple and sturdy machine: safe and easy to use



226



» Kod
Code

63010048

Model
Model

Et-Kemik Testeresi / Bone Saw

Bıçak Uzunluğu / Blade Length

1840 mm

Motor / Motor

1100 W / Hp 1,5

Makarna Pulley

250 mm

Net Ağırlık / Net Weight

40 Kg

Ölçüler / Dimensions

A	B	C	D	E	F	G
530 mm	600 mm	640 mm	950 mm	915 mm	250 mm	240 mm

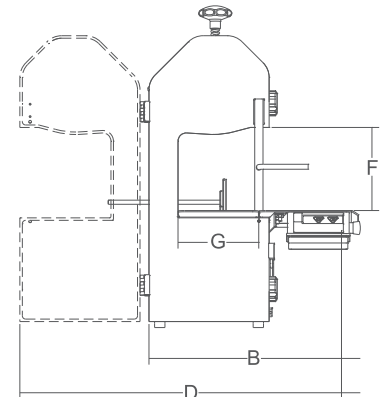
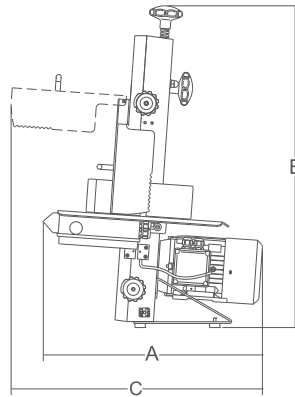

- Tezgah üstü model; Hijyenik ve paslanmaz polisajlı eloksallı alüminyum gövde
- Paslanmaz çelik kesim tablası, et itici ve et dilimleyici
- Kemik veya et kesmeye uygun 16 mm, geniş, güçlendirilmiş bıçaklar (donmuş ve taze)
- Kapı üzeri ve motor fren mikroswitchi (yeni CE güvenlik kurallarına göre)
- 24V emniyetli kontrol
- Makaraların yarı bükülmüş şekli sayesinde mükemmel bıçak-makara tutuşu
- Yağ keçesi ile korunan 4 kutuplu eşzamansız ve soğutmalı motor
- Güvenli ve kolay kullanım
- Table-top model; cast anodized aluminium alloy construction, polished, hygienic and rustproof
- Cutting table, meat pusher and meat slicer in stainless steel AISI 304
- 24V controls with safety codified microswitches on the door and motor brake (according to new CE safety rules)
- Powerful asynchronous and ventilated 4-pole motors protected by sealing oil ring
- 16 mm wide tempered ring-blades useful for cutting bones or meat (frozen or fresh)
- Simple and sturdy machine: safe and easy to use



227

» Kod
Code

63010028

Model
Model

Et-Kemik Testeresi / Bone Saw

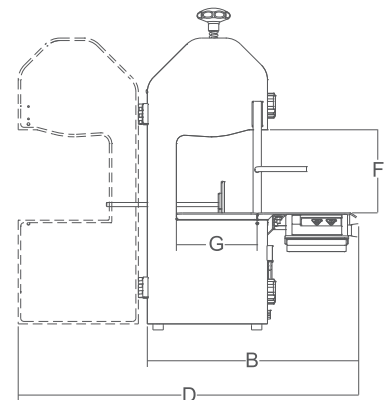
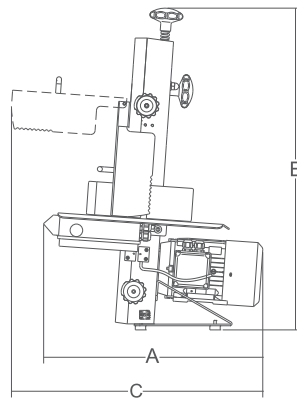

Bıçak Uzunluğu / Blade Length

1550 mm

Motor / Motor

1 ph-Hp 1/r.p.m. 1400

3 ph-Hp 1,5/r.p.m. 1400

Makarna Pulley

210 mm

Net Ağırlık / Net Weight

32 Kg

Ölçüler / Dimensions

A	B	C	D	E	F	G
530 mm	510 mm	606 mm	822 mm	778 mm	215 mm	195 mm

- Düşük hacimli ürünler için kompakt ve hızlı paketlenme
- Vakum ve yapıştırma zaman ayarı
- Gösterge Paneli: Vakum yüzdesi ve kalan zaman göstergesi
- Yağ değiştirme uyarısı
- Zaman ayarlı dış vakum
- DVP vakum pompası
- Softcooker cihazı ile ideal kombinasyon
- A compact and fast machine for small sized product
- Easily settable vacuum and sealing time
- Bush suction pump
- Display of vacuum percentage and time to countdown
- Rev counter and pump meter
- Pump preheating and oil cleaning cycle
- Change oil message
- Timed external vacuum

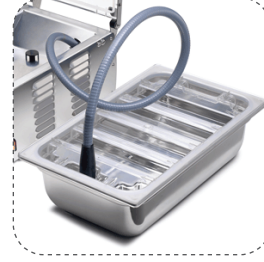

Güç / Power	0,1 kw
Güç Kaynağı / Power Source	230 V/50 Hz
Vakum Pompası / Vacuum Pump	mc/h 4
Net Ağırlık / Net Weight	30 Kg
Ölçüler / Dimensions	320x560x257 mm

228



» Kod
Code
63010030

Model
Model
Vakumlu Paket Makinesi
Vacuum Packaging Machines

- Vakum ve yapıştırma zaman ayarı
- Gösterge Paneli: Vakum yüzdesi ve kalan zaman göstergesi
- Son kullanılan ayarın hafızaya kaydedilebilme özelliği
- Her vakum döngüsünden sonra otomatik açılan kapak
- Yağ değiştirme uyarısı
- Zaman ayarlı dış vakum
- Ön ısıtma pompası ve yağ temizleme döngüsü

- Easy vacuum and sealing time setting
- Display of vacuum percentage and time to countdown
- Last setting saved in memory
- Rev counter and pump meter
- Pump preheating and oil cleaning cycle
- Oil change message
- Timed external vacuum
- Automatic cover lift operated by pneumatic pistons

Güç / Power	0,45 Kw
Güç Kaynağı / Power Source	230 V/50 Hz
Vakum Pompası / Vacuum Pump	mc/h 12
Net Ağırlık / Net Weight	54 Kg
Ölçüler / Dimensions	493x585x370 mm



» Kod
Code
63010035

Model
Model
Vakumlu Paket Makinesi
Vacuum Packaging Machines



- Düşük ısıda vakumlu gıda pişirme cihazı
- Hafızaya alınabilir 5 ayrı program
- 50 - 80 lt kullanım kapasitesi
- Isı göstergeli
- Sıvısız yanlış kullanım durumunda cihazı otomatik kapatan koruma sistemi
- Aşırı yükleme ve aşırı ısınmayı engelleyen ısı sensörü
- Kullanılan gıda konteynırına sabitleme kelepçesi (maks. Derinlik 16,5 cm)
- Kolay taşıma sağlayan paslanmaz çelik sap

- High precision warmer with temperature control
- Working temperature display
- 5 storable programs
- IP X3 protection rated stainless steel structure
- Can be applied to the pot by means of a clamp. (max depth 16,5 mc)
- Best performances up to 50/80 lt
- Protection device switches off the warmer in case of accidental use outside the liquid
- Circulating pump to help the best product mixing
- Temperature sensor to prevent overload and overheating
- A convenient stainless steel handle makes it easy to carry



230

» Kod
Code

63010051

Model
Model

Soft Cooker

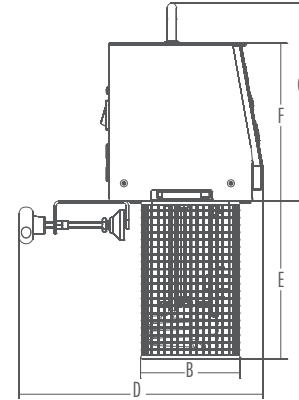
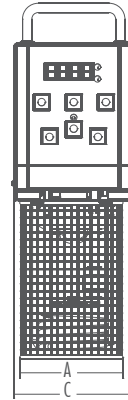

Güç / Power

2000 Watt

Güç Kaynağı / Power Source

230 V/50 Hz

Isı / Temperature

°C 40 / 115

Net Ağırlık / Net Weight

4,5 Kg

Ölçüler / Dimensions

A	B	C	D	E	E	G
110 mm	105 mm	130 mm	260 mm	170 mm	170 mm	210 mm

- Paslanmaz Çelik gövde ve GN 1/1 küvet
 - Hafızaya alınabilir 5 ayrı program
 - Isı göstergeli elektronik ısı kontrolü
 - Alt tankla bağlantılı darbe dayanıklı ısıtma parçaları
 - C° and F°'de ısı ayar seçenekleri
 - Kolay taşıma için pratik saplar
- Stainless steel structure and 1/1 GN made of stainless steel
 - Practical handles to carry it easily
 - Powerful shock-proof coated heating elements in contact with tank bottom
 - Electronic control system of the temperature with working temperature display
 - Same control system of Softcooker with delta T of 0,2°C
 - 5 storable programs
 - Temperature setting in C° and F°
 - Equipped with lid



» Kod
Code
63010049

Model
Model
Softcooker GN 1/1

231



Güç / Power
Güç Kaynağı / Power Source
Isı / Temperature
Net Ağırlık / Net Weight
Ölçüler / Dimensions

1150 Watt
230 V/50 Hz
°C 40 / 115
5 Kg
X Y H
110 mm 105 mm 130 mm

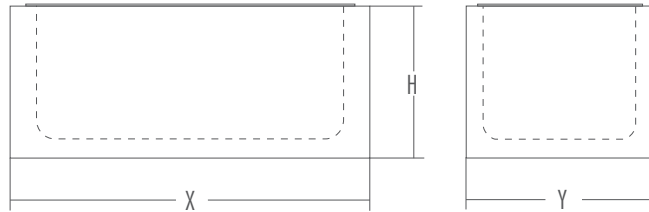

- Paslanmaz çelik gövde
- 2 ızgara ve mikrodalga seçeneği
- Kırılmaz camdan mamül döner tabak
- 30 dak. zaman ayarı
- 25 lt iç hacim
- Mikrodalga: 6 farklı güç seviyesi
- Ağırlık bazlı otomatik buz çözme
- Restaurant ve barlar için ideal
- 340x330xH.220 mm iç hacim
- 900 W çıkış gücü
- Stainless steel construction
- Tempered glass rotating plate
- Timer 30 min.
- Microwave: 6 different power levels
- 2 grill-microwave combination
- Weight-based automatic defrost
- Ideal for small restaurants and bars



Güç / Power

1400 W m.o./1000 W grill

Güç Kaynağı / Power Source

230 V/50 Hz

Güç Kademesi / Power Level

n. 5

Mikrodalga Frekansı / Microwave Frequency

MHz 2450

» Kod
Code

63010055

Model
ModelMikrodalga Fırın
Microwave Oven

232

Hazne kapasitesi / Inside Volume

25 Lt

Net Weight / Net Ağırlık

14,5 Kg

Ölçüler / Dimensions

483x422x281 mm



- Paslanmaz çelik kabin
- Cam seramik pişirme tepsi
- 5 ayrı güç seviyesi ile çok yönlü kullanım
- Zaman ve ısı ayarları için manuel kontrol
- 25 lt kapasite
- Restaurant ve barlar için ideal
- 330x360xH.200 mm iç hacim
- High versatility with 5 power levels
- Manual controls for power and timer
- Stainless steel cabinet and cavity finish
- Ceramic glass cooking plate
- See-through opening door with practical handle
- 25 lt inside volume
- Inner dimensions 330x360x200 mm



Güç / Power

1500 W

Güç Kaynağı / Power Source

230 V/50 Hz

Güç Kademesi / Power Level

n. 6

Mikrodalga Frekansı / Microwave Frequency

MHz 2450

Hazne kapasitesi / Inside Volume

25 Lt

Net Weight / Net Ağırlık

17,7 Kg

Ölçüler / Dimensions

520x442x312 mm

» Kod
Code

63010054

Model
ModelMikrodalga Fırın
Microwave Oven



» Kod
Code

63010019

Model
Model

İndüksiyon Ocak /
Induction Cooker

- Mutfakta,restoranda,yada yemek odalarında her kullanım yüzeyine uygun kurulumu kolay elektrikli ocak ızgara
- Duman bulundurmaması sayesinde umuma açık yerlerde ya da müşteri önünde pişirim yapmaya son derece elverişlidir
- Derecelendirilmiş dijital kontrol
- Kullanım ve temizlemesi çok kolaydır
- Pürüzsüz pişirme yüzeyi temizlemeyi kolaylaştırmaktadır
- Asla aşırı ısınmayan yüzeyi ile oldukça güvenlidir
- Elektrikli ocak ızgara ısıyı etkin kullanması ve asla aşırı ısınmaması sayesinde enerji tasarrufludur
- Tencere ocak üzerinden alındığında elektrik emilimi durur

- The induction hobs are easy to install on every working surface in kitchens, restaurants or dining rooms; thanks to the absence of fumes they are perfect for public cooking performances or when the preparation is made in view of customers
- Graduated digital controls
- Extremely easy to use and to clean
- Smooth cooking surface makes cleaning easy
- Safe operations are ensured by the cooking surface which is never heating up
- Induction hobs are energy saving thanks to heating efficiency and no need to heat up
- Electric absorption is stopped when the pan is removed from the hob surface

233

» Kod
Code

57103838

Model
Model

Gömme İndüksiyon Ocak /
Built-In Induction Cooker

Güç / Power

3500 W

Güç Kaynağı / Power Source

220-240 V/50-60 Hz F+N

Kullanılabilir Alan / Useful Surface

Ø 280 mm

Ölçüler / Dimensions

	A	B	C
	360 mm	380 mm	25 mm



- Güçlendirilmiş soğutmalı motor
- 20 adet ön-ayarlanabilir program
- 9 adet özel ayarlanabilir program seçeneği
- Program akışını ve makinenin çalışmasını görüntüleyen ekran
- 2 Litre kapasiteli, bulaşık makinasında yıkanabilir şeffaf hazne
- Dereceli hazne ve sızdırmaz kauçuk kapak
- Paslanmaz çelik 4 başlı bıçak
- Barmaster Q için;
- Pratik kullanım için 3 ayrı noktadan dökme imkanı
- Frozen ve Smoothie içecekler hazırlamak için mükemmel uyum

- 20 pre-set programs, of which 4 can be linked to 4 keys on the keypad and the other 16 can be recalled through the menu (all can be reprogrammed)
- 9 programs set in self-learning mode
- Display to view the programs and machine operation
- The square glass has been developed to ideally work with large quantities of ice, even dry
- 2 litre capacity, built out of transparent, indestructible Tritan, can be washed in dishwasher, graduated in litres, UK and U.S. gallons
- Glass lid in rubber with airtight seal with cap and graduated glass
- Knife support in stainless steel that can be fully and easily disassembled from the glass body. Knife with 4 spokes obtained from a single mould in tempered cutlery steel, easy to disassemble

Soğutmalı Motor
Ventilated Motor

Kod Code	Model Model
63010015	Kare Hazneli / Square Jug
63020015	Ses Geçirmez Kare Hazneli / Square Jug w/Sound Enclosure
63010041	Ses Geçirmez Yuvarlak Hazneli / Round Jug w/Sound Enclosure



Güç / Power
Güç Kaynağı / Power Source
Motor / Motor
Hazne Kapasitesi / Jug Capacity
Net Ağırlık / Net Weight
Ölçüler / Dimensions

750 W - Hp 1
230 V/50-60 Hz F+N
r.p.m. 14.000+24.000
2 Lt
5 Kg

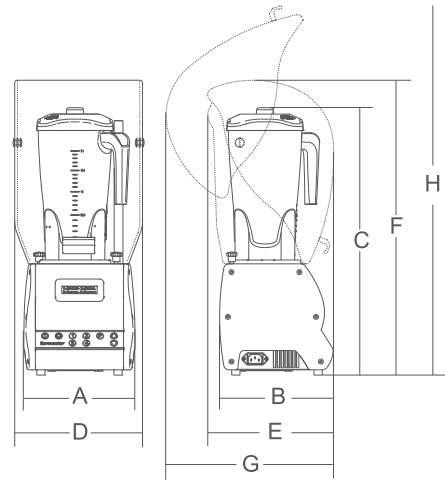

A 200 mm B 200 mm C 485 mm D 240 mm E 230 mm F 535 mm G 315 mm H 670 mm

- Güçlendirilmiş soğutmalı motor
- Mekanizmadaki sert kauçuk sayesinde sessiz çalışma
- Kapakta mıknatıslı güvenlik kilidi
- Hız kontrollü açma kapama düğmesi
- 2 Litre kapasiteli, bulaşık makinasında yıkanabilir şeffaf hazne
- Cam hazneden kolayca ayrılabilen paslanmaz çelik bıçak desteği
- Paslanmaz çelik 4 başlı bıçak
- Machine structure in extruded aluminium and sides in ABS with 1 or 2 glasses for the aluminium version and machine structure in stainless steel for the stainless steel version
- Powerful motor with forced ventilation, for prolonged use and enhanced durability
- Reliable low-noise transmission system in vulcanized rubber
- Magnetic safety micro-switch on glass lid without forced position
- 2 litre capacity, built out of transparent, indestructible Tritan, can be washed in dishwasher, graduated in litres, UK and U.S. gallons, or 2 litre and 5 litre glass in stainless steel for the Five version
- Glass lid in rubber or polyester for Orion Five, both with airtight seal with cap and graduated glass
- Knife support in stainless steel that can be fully and easily disassembled from the glass body

Soğutmalı Motor
Ventilated Motor



» Kod
Code

63010014
63010040

Model
Model

Yuvarlak Hazneli / Round Jug
Kare Hazneli / Square Jug

235



Volkanize kauçuk mekanizma
Vulcanized rubber gears



Milkshake aparatı
Milkshake application

Güç / Power	750 W - Hp 1
Güç Kaynağı / Power Source	230 V/50-60 Hz F+N
Motor / Motor	r.p.m. 14.000+24.000
Hazne Kapasitesi / Jug Capacity	2 Lt
Net Ağırlık / Net Weight	5 Kg
Ölçüler / Dimensions	A B C 200 mm 200 mm 470 mm

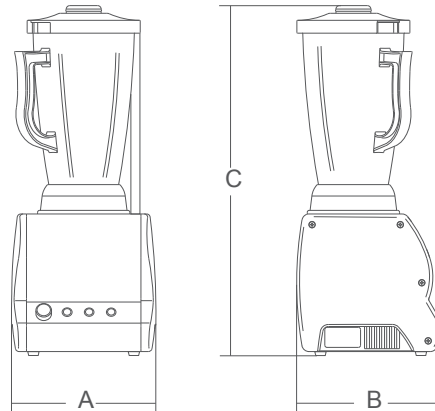

- Yüksek güçlü, soğutmalı motor
- Şeffaf, 1,5 litrelik, bulaşık makinesinde yıkanabilen hazne
- Çalışma esnasında malzeme eklemeye uygun sızdırmaz kapak
- Sertleştirilmiş kauçuk dişliler ile yüksek güç iletimi ve sessiz çalışma
- 4 parçalı sökülebilir paslanmaz çelik bıçak
- Kapakta emniyet kilidi
- Powerful ventilated motor
- Transparent, unbreakable 1,5 Lt Tritan container is dishwasher safe and graduated with litres and gallons
- Tight rubber lid with feed opening to add ingredients while the blender is working
- Vulcanized rubber gears drive gives a high power transmission and quiet operation
- 4-blades stainless steel knife can be easily disassembled
- Safety microswitch on the lid



Soğutmalı Motor
Ventilated Motor



Güç / Power	450 W - Hp 0,60
Güç Kaynağı / Power Source	230 V 50/60 Hz F+N
Motor / Motor	r.p.m. 18.000
Hazne Kapasitesi / Jug Capacity	0,55 Lt
Net Ağırlık / Net Weight	3 Kg
Ölçüler / Dimensions	213x200x416 mm

» Kod Code	Model Model
63010013	Blender

236



- Şeffaf 550 cc Tritan hazne
- Daha uzun ömür için soğutmalı motor
- Kokteyl ya da içecek hazırlamak için üç alüminyum pimli ve paslanmaz çelik başlıklı karıştırıcı ya da donmuş kahve veya kremli sonuçlar için özel yuvarlak karıştırıcı
- Hazne mekanizmasında güvenlik kilidi

- Transparent 550 cc Tritan cup or stainless steel cup on request
- 900 cc stainless steel cup on 120 W version
- Powerful ventilated motor for a longer life
- Spindle with three aluminium and s/steel agitators for preparing cocktails and drinks, or with a special round agitator for frozen coffees or for creamier results
- Safety microswitch on the cup support

Güç / Power	100 W
Güç Kaynağı / Power Source	230 V 50/60 Hz F+N
Motor / Motor	r.p.m. 14.000
Hazne Kapasitesi / Jug Capacity	0,55 Lt
Net Ağırlık / Net Weight	2,5 Kg
Ölçüler / Dimensions	150x195x485 mm

» Kod Code	Model Model
63010011	İçecek Mikseri / Beverage Mixer

- Yuvarlak tasarımlı , ticari kullanıma uygun
- Krom gövde, kolay temizlik için köşesiz ve eksiz tasarım
- Sökülebilir paslanmaz çelik hazne kolay temizlenebilir ve bulaşık makinasında kullanıma uygun
- Maksimum verimlilik için tek parça sıkacak ve süzgeç
- Gıda temasını önlemek için alüminyum paslanmaz çelik seviye ayarlayıcı
- Meyve aşağı itildiğinde cihazın çalışmasını sağlayan patentli güvenlik şalteri
- Commercial easy to use citrus juicer with round design
- Chrome body, no edges or seams for easy cleaning
- Stainless steel bowl is removable for cleaning and is dishwasher safe, ABS bowl available on request
- Reamer and sieve are one piece to squeeze with the maximum efficiency
- Aluminium stainless steel lever to avoid any food contact is available on request
- Patented safety microswitch on the cone allows to activate the juicer when the product is pushed down
- The juicer is available without microswitch as well
- Speed control on request



» Kod Code Model Model
63010016 Narenciye Sıkacağı / Citrus Juicer

Güç / Power 150 W
Güç Kaynağı / Power Source 230 V /50-60 Hz F+N
Devir/Dakika / Revolutions/min. r.p.m. 320
Net Ağırlık / Net Weight 3 Kg
Ölçüler / Dimensions 210x210x280 mm



» Kod Code Model Model
63010017 Narenciye Sıkacağı Kapaklı / Citrus Juicer w/Lever

- Yuvarlak tasarımlı , ticari kullanıma uygun
- Krom gövde, kolay temizlik için köşesiz ve eksiz tasarım
- Sökülebilir paslanmaz çelik hazne kolay temizlenebilir ve bulaşık makinasında kullanıma uygun
- Maksimum verimlilik için tek parça sıkacak ve süzgeç
- Gıda temasını önlemek için alüminyum paslanmaz çelik seviye ayarlayıcı
- Meyve aşağı itildiğinde cihazın çalışmasını sağlayan patentli güvenlik şalteri
- İsteğe bağlı hız kontrolü
- Mikroanahtarsiz sıklık da mevcuttur

- Commercial easy to use citrus juicer with round design
- Chrome body, no edges or seams for easy cleaning
- Stainless steel bowl is removable for cleaning and is dishwasher safe, ABS bowl available on request
- Reamer and sieve are one piece to squeeze with the maximum efficiency
- Aluminium stainless steel lever to avoid any food contact is available on request
- Patented safety microswitch on the cone allows to activate the juicer when the product is pushed down
- The juicer is available without microswitch as well
- Speed control on request

Güç / Power 150 W
Güç Kaynağı / Power Source 230 V /50-60 Hz F+N
Devir/Dakika / Revolutions/min. r.p.m. 320
Net Ağırlık / Net Weight 3,5 Kg
Ölçüler / Dimensions 210x210x280 mm

- Çekme alüminyum iskelet, ABS gövde
 - Kuru buz için ideal
 - Buz kalınlığı ayarlama
 - Buzu direk bardağa dökebilme kolaylığı
 - Mikroswitch kapaklı paslanmaz çelik 3 lt hazne
 - 800 r.p.m. (devir)
 - Bronzdan imal dişli motor redüktörü
- Professional ice crusher, an indispensable bar tool for preparing drinks and frozen cocktails and in the restaurant for displaying fish or fresh foods
 - Crushes any ice cubes made with an ice cube machine up to 40x40mm at -3° C
 - Its discharge adjustment lets you regulate the average size of the crushed ice
 - Extruded aluminium body, stainless steel container, food-grade ABS opening and s/steel blades
 - Ventilated motor with gear transmission for prolonged use, micro-switch on the lid for maximum operator safety



238

Kod Code	Model Model
63010039	Buz Kırıcı / Ice Crusher



Güç / Power	150 W
Güç Kaynağı / Power Source	230 V 50/60 Hz F+N
Bıçak Hızı / Blade Speed	r.p.m. 800
Hazne Kapasitesi / Jug Capacity	3 Lt
Net Ağırlık / Net Weight	5,2 Kg
Ölçüler / Dimensions	A 205 mm B 285 mm C 491 mm D 235 mm

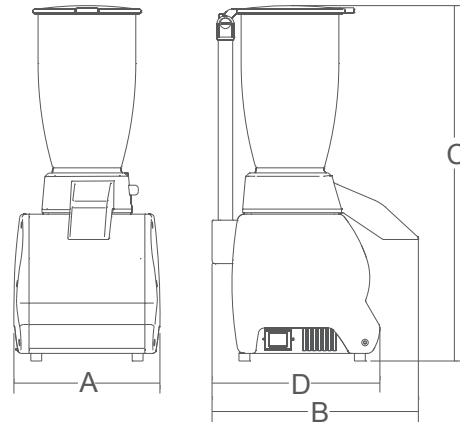

Made in Italy

- Triton bıçağı ayarlamayla buzı farklı boyutlarda kırmayı sağlar
- Geleneksel İtalyan granitası için düzgün kırılmış buz
- Buzlu kokteyller veya soğuk mezelerin servis ve sunumu için kar buzları
- Besleme ağzında mikro güvenlik anahtarı
- Toplama haznesinde mikro güvenlik anahtarı
- Polisajlı alüminyum besleme ağız
- Paslanmaz çelik parça ve ayrıntılar
- Alüminyum ve paslanmaz çelik iç yapı
- Termo formulu gıdaya uygun plastikten gövde ve hazne
- Düşük emiş gücü için oluklu kayış

- Triton allows to crush ice in different sizes by adjusting the blade:
 - Finely crushed ice for the traditional Italian granitas
 - Flakes for frozen cocktails or to serve or display cold dishes
- Safety microswitch on the feeding mouth
- Safety microswitch on the collecting tray
- Polished aluminium feeding mouth
- Stainless steel parts and details
- Aluminium and stainless steel internal structure
- Body and tray are made from thermoformed alimentary plastic
- Ribbed belt for low power absorption.



» Kod
Code

63010018

Model
Model

Buz Kırıcı / Ice Crusher



Kesme kalınlığı ayarlama kolu
Cut thickness adjusting knob



Mikro anahtarlı hazne
Collecting tray with microswitch



Besleme ağzında mikro güvenlik anahtarı
Microswitch on the lever

239

Güç / Power

350 W

Güç Kaynağı / Power Source

230 V/50-60 Hz F+N

Motor / Motor

r.p.m. 12000

Bıçak Hızı / Blade Speed

r.p.m. 1500

Max. Buz Kalınlığı / Crushed Ice Max. Thickness

10 mm

Hazne Kapasitesi / Jug Capacity

2 Lt

Net Ağırlık / Net Weight

8,5 Kg

Ölçüler / Dimensions

A B C D E
365 mm 210 mm 465 mm 295 mm 480 mm

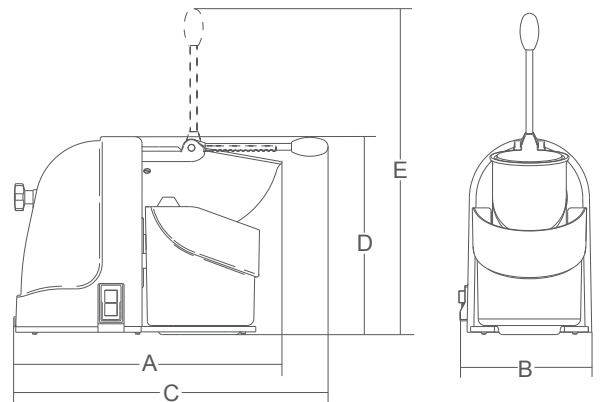



Taşıma/Carrying



Taşıma Kovaları / Carrying Containers



» Tabansız (Kapaklı)
w/o Sandwich Bottom

Kod Code	Øxh (cm) Øxh (cm)	Lt Lt	Koli/Adet Pcs/Ctn
35512428	24x28	12,5	4
35513028	30x28	20	2
35513032	30x32	21	2
35513636	36x36	36,6	1
35514040	40x40	50	1
35514545	45x45	70	1
35515050	50x50	100	1



» Tabansız (Silikon Conta Kapaklı)
w/o Sandwich Bottom-Lid w/Silicone Seal

Kod Code	Øxh (cm) Øxh (cm)	Lt Lt	Koli/Adet Pcs/Ctn
35532428	24x28	12,5	4
35533028	30x28	20	2
35533032	30x32	21	2
35533636	36x36	36,6	1
35534040	40x40	50	1
35534545	45x45	70	1

* Ø36, Ø40, Ø45 ölçüleri sabit saplıdır
* Ø36, Ø40, Ø45 has fixed handles



» Tabanlı (Kapaklı)
w/Sandwich Bottom

Kod Code	Øxh (cm) Øxh (cm)	Lt Lt	Koli/Adet Pcs/Ctn
35502428	24x28	12,5	4
35503028	30x28	20	2
35503032	30x32	21	2
35503636	36x36	36,6	1
35504040	40x40	50	1
35504545	45x45	70	1
35505050	50x50	100	1

* Ø36, Ø40, Ø45 ölçüleri sabit saplıdır
* Ø36, Ø40, Ø45 has fixed handles

242



» Tabanlı (Silikon Conta Kapaklı)
w/Sandwich Bottom-Lid w/Silicone Seal

Kod Code	Øxh (cm) Øxh (cm)	Lt Lt	Koli/Adet Pcs/Ctn
35542428	24x28	12,5	4
35543028	30x28	20	2
35543032	30x32	21	2
35543636	36x36	36,6	1
35544040	40x40	50	1
35544545	45x45	70	1



» İzoleli
Double Wall Container

Kod Code	Øxh (cm) Øxh (cm)	Lt Lt	Koli/Adet Pcs/Ctn
35503217	32x17	10	1
35503222	32x22	14	1
35503230	32x30	20	1
35503236	32x36	24	1
35503248	32x48	32	1
35505030	50x30	43	1



» Musluklu
Container w/Faucet

Kod Code	Øxh (cm) Øxh (cm)	Lt Lt	Koli/Adet Pcs/Ctn
35412428	24x28	12,5	4
35413028	30x28	20	2
35413032	30x32	21	2
35413636	36x36	36,6	1
35414040	40x40	50	1
35414545	45x45	70	1
35415050	50x50	100	1

» Silikon Conta
Silicone Seals



Kod Code	Ø (cm) Ø (cm)	Koli/Adet Pcs/Ctn
35510024	24	2
35510030	30	2
35510036	36	2
35510040	40	2
35510045	45	2

* Gıda tüzüğüne uygundur.
* Food safe compliances.





» Sefer Tası Standart
Standard

Kod Code	Øxh (cm) Øxh (cm)	AdxLt Pcs/Lt	Koli/Adet Pcs/Ctn
30631808	18x8x3	3x2	4
30641808	18x8x4	4x2	4
30632010	20x9x3	3x3	4
30642010	20x9x4	4x3	4
30632414	24x14x3	3x6	2
30642414	24x14x4	4x6	2
30633014	30x14x3	3x10	1
30643014	30x14x4	4x10	2



» Sefer Tası İzoleli
Double Wall

Kod Code	Øxh (cm) Øxh (cm)	AdxLt Pcs/Lt	Koli/Adet Pcs/Ctn
35502092	20x11x2	2x3	4
35502093	20x11x3	3x3	4
35502094	20x11x4	3x4	4



» Taşıma Tepsisi Kapaklı
Carrying Tray w/Clip-on Cover

Kod Code	Ölçü Dims. (cm)	Koli/Adet Pcs/Ctn
30714565	40x60x5	2
30714568	40x60x8	2
30714561	40x60x10	2
30715355	50x35x5	2
30715358	50x35x8	2
30715310	50x35x10	2
30715705	50x70x5	3
30715708	50x70x8	3
30715710	50x70x10	3



» Taşıma Tepsisi Kapaksız
Carrying Tray

Kod Code	Ölçü Dims. (cm)	Koli/Adet Pcs/Ctn
30704565	40x60x5	2
30704568	40x60x8	2
30704561	40x60x10	2
30705355	50x35x5	2
30705358	50x35x8	2
30705310	50x35x10	2
30705705	50x70x5	3
30705708	50x70x8	3
30705710	50x70x10	3



» Kapak
Cover

Kod Code	Ölçü Dims. (cm)	Koli/Adet Pcs/Ctn
30705711	40x60	1
30705713	50x35	1
30705712	50x70	1

- Bulaşık makinesinde yıkanabilir
- +100°C ısıya, -40°C soğuğa dayanıklıdır
- Kolay temizlenebilir ve hijyenik parlak ve pürüzsüz iç yüzey
- Ekstra güçlendirilmiş köşeler
- 53 lt-63 lt arası taşıma kapasitesi
- Hafif gövde yapısı sayesinde kolay taşınabilirlik
- Üst üste dizilebilir
- Çift cidarlıdır. Cidarlar arasında poliüretan köpük kullanılmıştır
- İnsan sağlığına zararlı madde içermemektedir
- Talebe göre renk seçenekleriyle üretilebilir

- Dishwasher safe
- Can withstand temperatures from -40°C to +100°C
- Smooth inside surface that is hygienic and easy to clean
- Features tough reinforced corners
- Can carry from 53 to 63 lt
- Light case that is easy to lift
- Stackable
- Double walls filled with polyurethane foam
- Does not contain any substances harmful to human health
- Other colours available upon request



244



4 adet 10 cm derinlikte követlerde 88°C'lik sıcak su ve 0,5°C'lik soğuk su ile test edilmiştir.
Tested with four 10 cm deep trays filled with hot water at 88°C and with cold water at 0,5°C

TESTLER	Başlangıç	1 Saat	2 Saat	3 Saat	4 Saat	5 Saat
SICAK / HOT	88°C	83°C	81,9°C	80,2°C	79°C	77,6°C
SOGUK / COLD	0,5°C	1°C	1,5°C	2°C	2,4°C	2,8°C



*Renk Seçenekleri
*Colour options



İç Ölçüler / Inner Dimensions : 33x52x50 cm
Dış Ölçüler / Outer Dimensions : 44x66x63 cm
Ağırlık / Weight : 14 Kg

» Thermobox 600 Mentesele
Thermobox 600 (Side-Hinged)

Kod Code	Koli/Adet Pcs/Ctn
46011600	1

245



İç Ölçüler / Inner Dimensions : 33x52x50 cm
Dış Ölçüler / Outer Dimensions : 44x66x63 cm
Ağırlık / Weight : 13,5 Kg

» Thermobox 600
Thermobox 600

Kod Code	Koli/Adet Pcs/Ctn
46010600	1



* Önden yüklemeli model. Max. GN 1/1 küvet kullanımına uygundur.
* Front loading model. Designed for GN Food Pan Standards.



*Renk Seçenekleri
*Colour options



» İçecek Thermobox
Beverage Thermobox

Kod Code	Lt Lt	Koli/Adet Pcs/Ctn
43020300	23	1



» Yiyecek & İçecek Thermobox
Food & Beverage Thermobox

Kod Code	Lt Lt	Koli/Adet Pcs/Ctn
43020250	33	1



* Üstten yüklemeli model. Max. GN 1/1 kuvvet kullanımına uygundur.
* Overhead loading model. Designed for GN Food Pan Standards

» Thermobox
Standard

Kod Code	Ölçü (mm) Dim. (mm)	Model Model	Koli/Adet Pcs/Ctn
43020100	635x435x200	Max. GN 1/1-100	1
43120100	635x435x200	Max. GN 1/1-100	1
43220100	635x435x200	Max. GN 1/1-100	1
43320100	635x435x200	Max. GN 1/1-100	1
43020150	635x435x250	Max. GN 1/1-150	1
43120150	635x435x250	Max. GN 1/1-150	1
43220150	635x435x250	Max. GN 1/1-150	1
43320150	635x435x250	Max. GN 1/1-150	1
43020200	635x435x310	Max. GN 1/1-200	1
43120200	635x435x310	Max. GN 1/1-200	1
43220200	635x435x310	Max. GN 1/1-200	1
43320200	635x435x310	Max. GN 1/1-200	1

430 431 432 433



*Aksesuarlar hariçtir
* w/o Accessories

» Termo Tepsi
Isothermic Tray

Kod Code	Ölçü (mm) Dim. (mm)	Model Model	Koli/Adet Pcs/Ctn
43020105	530x370x120	5 Gözlü 5 Partition	1
43020106	530x370x120	6 Gözlü 6 Partition	1



Servis Arabası (Açık)
» Serving Trolley

Kod Code	Ölçü (cm) Dim. (cm)	Koli/Adet Pcs/Ctn
46010028	107x52x96	1

* Kovalar fiyata dahil değildir. * Kovalar fiyata dahil değildir.



» Servis Arabası (Kapalı)
Serving Trolley (Closed)

Kod Code	Ölçü (cm) Dim. (cm)	Koli/Adet Pcs/Ctn
46010027	98x53x93	1



Servis Arabası Kahverengi (Açık)
» Serving Trolley Brown

Kod Code	Ölçü (cm) Dim. (cm)	Koli/Adet Pcs/Ctn
46110028	107x52x96	1

* Kovalar fiyata dahil değildir.
* Kovalar fiyata dahil değildir.



» Servis Arabası Kahverengi (Kapalı)
Serving Trolley Brown (Closed)

Kod Code	Ölçü (cm) Dim. (cm)	Koli/Adet Pcs/Ctn
46110027	98x53x93	1

247



» 5 Katlı Açık Servis Rafı
Serving Trolley 5 Shelved

Kod Code	Ölçü (cm) Dim. (cm)	Koli/Adet Pcs/Ctn
46011029	160x80x50	1



» 5 Katlı Kapalı Servis Rafı
Serving Trolley 5 Shelved (Closed)

Kod Code	Ölçü (cm) Dim. (cm)	Koli/Adet Pcs/Ctn
46011030	160x80x50	1



» 2 Katlı Servis Arabası (Demonte)
Demontable Service Trolley

Kod Code	Ölçü (cm) Dim. (cm)	Koli/Adet Pcs/Ctn
34266018	90x60x18	1



» 3 Katlı Servis Arabası (Demonte)
Demontable Service Trolley

Kod Code	Ölçü (cm) Dim. (cm)	Koli/Adet Pcs/Ctn
34266022	90x60x22	1

248



» 3 Katlı Servis Arabası (Monoblok)
Monoblock Service Trolley

Kod Code	Ölçü (cm) Dim. (cm)	Koli/Adet Pcs/Ctn
43010002	98x58,5x88	1

* Çöp aparatı hariçtir.
* w/o Waste bin.



» Çöp Kovası
Waste Bin

Kod Code	Ölçü (cm) Dim. (cm)	Koli/Adet Pcs/Ctn
43010011	33,5x23x44,5	2



» Küver Kabı
Cutlery Bin

Kod Code	Ölçü (cm) Dim. (cm)	Koli/Adet Pcs/Ctn
43010012	33,5x23x18	2



» Taşıma Kutusu
Bus Box

Kod Code	Ölçü (cm) Dim. (cm)	Koli/Adet Pcs/Ctn
60020010	54x39x20	2



» Çatal Kaşık Kutusu
4 Compartment Cutlery Holder

Kod Code	Ölçü (cm) Dim. (cm)	Koli/Adet Pcs/Ctn
60020011	52x29x9,5	6

* Tüm ürünler servis arabaları üzerinde kullanıma uygun ebatlardadır.
* All products are suitable for serving trolleys.



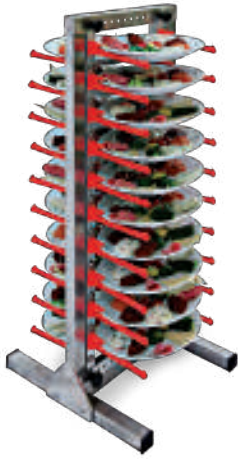

» Tabak İstif Ünitesi
Table Top Plate Rack

250

Kod Code	Kapasite Capacity	Koli/Adet Pcs/Ctn
43010015	20 Tabak 20 Plate	1

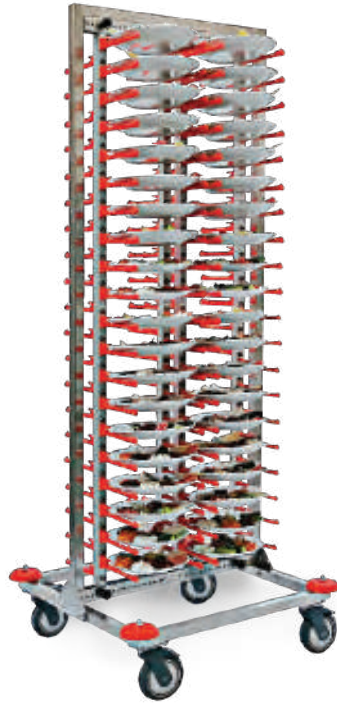

» Tabak İstif Arabası
Mobile Plate Rack

Kod Code	Kapasite Capacity	Koli/Adet Pcs/Ctn
43010014	80 Tabak 80 Plate	1



» Kaset Taşıma Arabası
Rack Trolley

Kod Code	Kapasite Capacity	Ölçü (cm) Dim. (cm)	Koli/Adet Pcs/Ctn
48010005	5 Kaset 5 Rails	37x53	1
48010010	10 Kaset 10 Rails	37x53	



» Tabak Taşıma Arabası Ayarlanabilir
Adjustable Dish Dolly

Kod Code	Koli/Adet Pcs/Ctn
43010013	1



» Erzak Arabası
Ingredient Bin w/Sliding Lid

plast|port[®]
by KAPP

Kod Code	Lt Lt	Ölçü (cm) Dim. (cm)	Koli/Adet Pcs/Ctn
46010010	102	42x75x71	1



» Bulaşık Toplama Arabası
Utility Rack

Kod Code	Model Model	Kapasite Capacity	Ölçü (cm) Dim. (cm)	Koli/Adet Pcs/Ctn
48013753	Tekli Single	13 Ad. 37x53 Tepsi 13 Pcs. 37x53 Tray	43x56x171	1
48023753	İkili Double	26 Ad. 37x53 Tepsi 26 Pcs. 37x53 Tray	83x56x171	1
48033753	Üçlü Triple	39 Ad. 37x53 Tepsi 39 Pcs. 37x53 Tray	123x56x171	1
48043753	Dörtlü Quadriple	52 Ad. 37x53 Tepsi 52 Pcs. 37x53 Tray	175x77x171	1



» Tepsi Taşıma Arabası
Tray Cart

Kod Code	Model Model	Kapasite Capacity	Ölçü (cm) Dim. (cm)	Koli/Adet Pcs/Ctn
48014060	Tekli Single	15 Ad. 40x60 Tepsi 15 Pcs. 40x60 Tray	40x63x165	1
48024060	İkili Double	30 Ad. 40x60 Tepsi 30 Pcs. 40x60 Tray	90x63x165	1
48015070	Tekli Single	15 Ad. 50x70 Tepsi 15 Pcs. 50x70 Tray	56x73x170	1

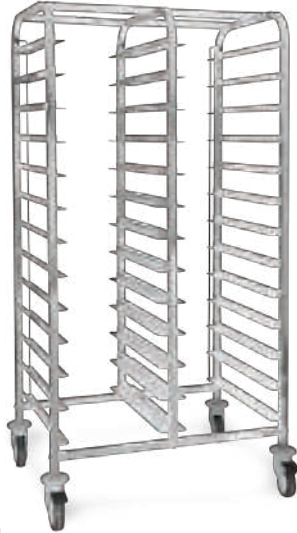

» Tepsi Tasıma Arabası GN 1/1
Tray Cart GN 1/1

Kod Code	Model Model	Kapasite Capacity	Ölçü (cm) Dim. (cm)	Koli/Adet Pcs/Ctn
48011009	Tekli Single	9 Ad. GN 1/1 Tepsi 9 Pcs. GN 1/1 Tray	38x56x105	1
48011017	Tekli Single	17 Ad. GN 1/1 Tepsi 17 Pcs. GN 1/1 Tray	38x56x172	1
48011034	İkili Double	34 Ad. GN 1/1 Tepsi 34 Pcs. GN 1/1 Tray	74x56x172	1



» Tepsi Tasıma Arabası GN 2/1
Tray Cart GN 2/1

Kod Code	Model Model	Kapasite Capacity	Ölçü (cm) Dim. (cm)	Koli/Adet Pcs/Ctn
48012109	Tekli Single	9 Ad. GN 2/1 Tepsi 9 Pcs. GN 2/1 Tray	59x68x105	1
48012117	Tekli Single	17 Ad. GN 2/1 Tepsi 17 Pcs. GN 2/1 Tray	59x68x172	1
48012134	İkili Double	34 Ad. GN 2/1 Tepsi 34 Pcs. GN 2/1 Tray	115x68x172	1

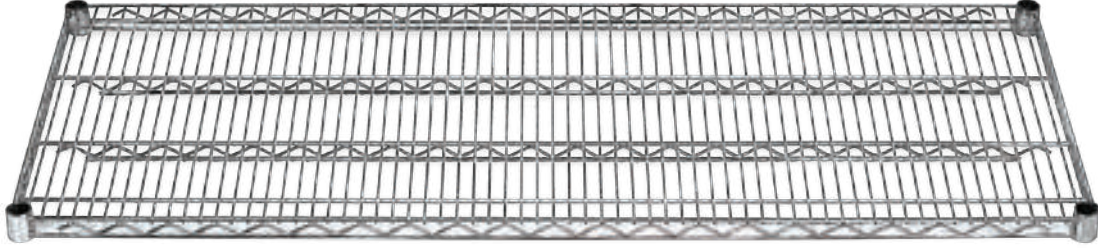

» Tel Raf

Perforated Shelves

Kod Code	Ölçü (mm) Dim. (mm)	Koli/Adet Pcs/Ctn
50204661	360x610	1
50204676	360x760	1
50204691	360x910	1
50246107	360x1070	1
50246122	360x1220	1
50246137	360x1370	1
50246152	360x1520	1
50246183	360x1830	1

» Tel Raf

Perforated Shelves

Kod Code	Ölçü (mm) Dim. (mm)	Koli/Adet Pcs/Ctn
50204661	460x610	1
50204676	460x760	1
50204691	460x910	1
50246107	460x1070	1
50246122	460x1220	1
50246137	460x1370	1
50246152	460x1520	1
50246183	460x1830	1

252

» Tel Raf

Perforated Shelves

Kod Code	Ölçü (mm) Dim. (mm)	Koli/Adet Pcs/Ctn
50205361	530x610	1
50205376	530x760	1
50205391	530x910	1
50253107	530x1070	1
50253122	530x1220	1
50253137	530x1370	1
50253152	530x1520	1
50253183	530x1830	1

» Tel Raf

Perforated Shelves

Kod Code	Ölçü (mm) Dim. (mm)	Koli/Adet Pcs/Ctn
50206161	610x610	1
50206176	610x760	1
50206191	610x910	1
50261107	610x1070	1
50261122	610x1220	1
50261137	610x1370	1
50261152	610x1520	1
50261183	610x1830	1

» Yükseltici

Elevator

Kod Code	Ölçü (mm) Dim. (mm)	Koli/Adet Pcs/Ctn
50201600	1600	4
50201800	1800	4



Tel Raflar 4 Katlı / Perforated Shelves w/4 Floor



» Tel Raf 4 Katlı

Perforated Shelves w/4 Floor

Kod Code	Ölçü (mm) Dim. (mm)	Koli/Adet Pcs/Ctn
50503661	360x610x1600	1
50503676	360x760x1600	1
50503691	360x910x1600	1
50536107	360x1070x1600	1
50536122	360x1220x1600	1
50536137	360x1370x1600	1
50536152	360x1520x1600	1
50536183	360x1830x1600	1

» Tel Raf 4 Katlı

Perforated Shelves w/4 Floor

Kod Code	Ölçü (mm) Dim. (mm)	Koli/Adet Pcs/Ctn
50504661	460x610x1600	1
50504676	460x760x1600	1
50504691	460x910x1600	1
50546107	460x1070x1600	1
50546122	460x1220x1600	1
50546137	460x1370x1600	1
50546152	460x1520x1600	1
50546183	460x1830x1600	1

» Tel Raf 4 Katlı

Perforated Shelves w/4 Floor

Kod Code	Ölçü (mm) Dim. (mm)	Koli/Adet Pcs/Ctn
50505361	530x610x1600	1
50505376	530x760x1600	1
50505391	530x910x1600	1
50553107	530x1070x1600	1
50553122	530x1220x1600	1
50553137	530x1370x1600	1
50553152	530x1520x1600	1
50553183	530x1830x1600	1

» Tel Raf 4 Katlı

Perforated Shelves w/4 Floor

Kod Code	Ölçü (mm) Dim. (mm)	Koli/Adet Pcs/Ctn
50506161	610x610x1600	1
50506176	610x760x1600	1
50506191	610x910x1600	1
50561107	610x1070x1600	1
50561122	610x1220x1600	1
50561137	610x1370x1600	1
50561152	610x1520x1600	1
50561183	610x1830x1600	1

» Tel Raf 4 Katlı

Perforated Shelves w/4 Floor

Kod Code	Ölçü (mm) Dim. (mm)	Koli/Adet Pcs/Ctn
50703661	360x610x1800	1
50703676	360x760x1800	1
50703691	360x910x1800	1
50736107	360x1070x1800	1
50736122	360x1220x1800	1
50736137	360x1370x1800	1
50736152	360x1520x1800	1
50736183	360x1830x1800	1

253

» Tel Raf 4 Katlı

Perforated Shelves w/4 Floor

Kod Code	Ölçü (mm) Dim. (mm)	Koli/Adet Pcs/Ctn
50704661	460x610x1800	1
50704676	460x760x1800	1
50704691	460x910x1800	1
50746107	460x1070x1800	1
50746122	460x1220x1800	1
50746137	460x1370x1800	1
50746152	460x1520x1800	1
50746183	460x1830x1800	1

» Tel Raf 4 Katlı

Perforated Shelves w/4 Floor

Kod Code	Ölçü (mm) Dim. (mm)	Koli/Adet Pcs/Ctn
50705361	530x610x1800	1
50705376	530x760x1800	1
50705391	530x910x1800	1
50753107	530x1070x1800	1
50753122	530x1220x1800	1
50753137	530x1370x1800	1
50753152	530x1520x1800	1
50753183	530x1830x1800	1

» Tel Raf 4 Katlı

Perforated Shelves w/4 Floor

Kod Code	Ölçü (mm) Dim. (mm)	Koli/Adet Pcs/Ctn
50706161	610x610x1800	1
50706176	610x760x1800	1
50706191	610x910x1800	1
50761107	610x1070x1800	1
50761122	610x1220x1800	1
50761137	610x1370x1800	1
50761152	610x1520x1800	1
50761183	610x1830x1800	1

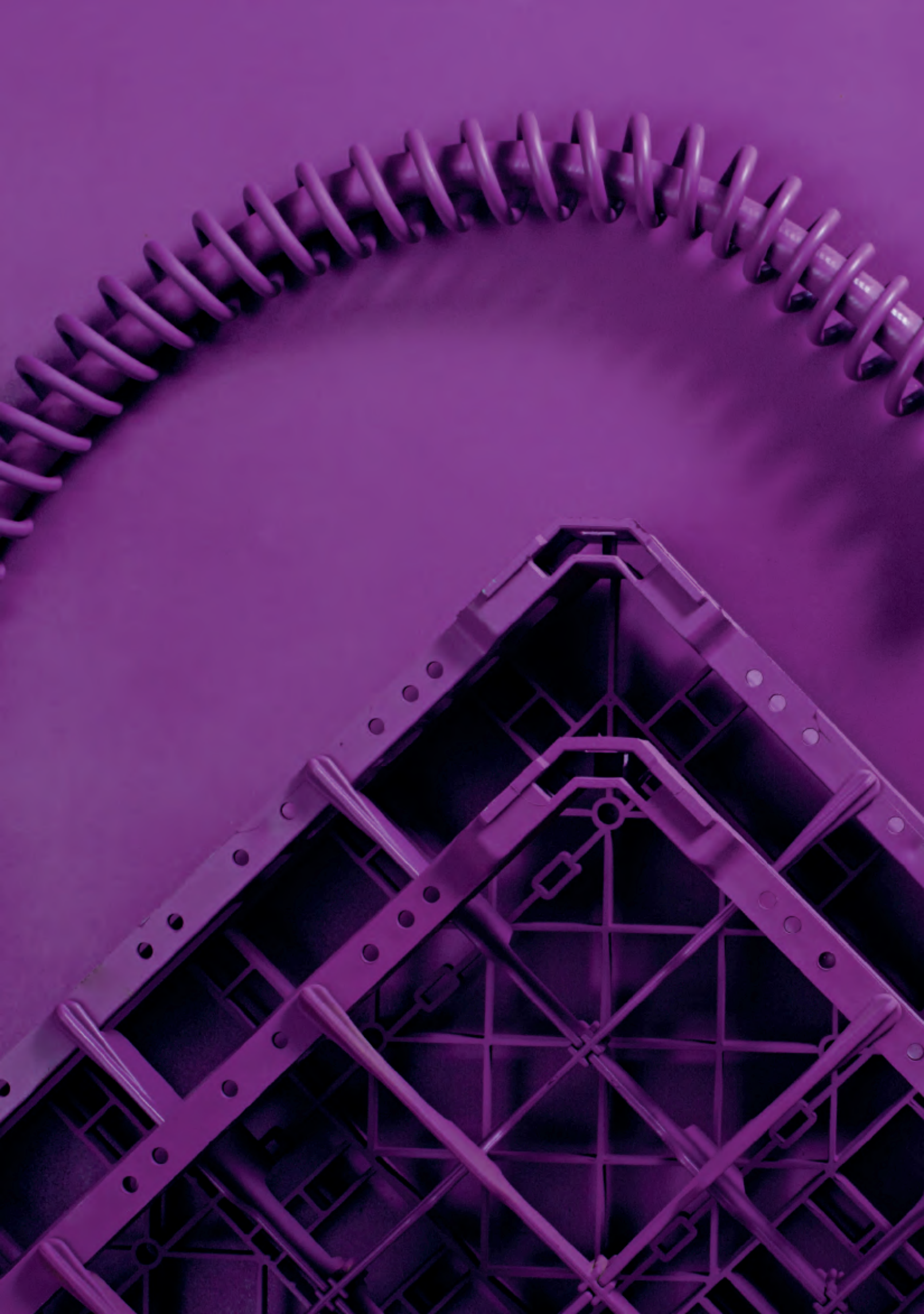

Bulaşık/Dish Washing





256



» Tabak Basketi
Plate/Trays Rack

Kod Code	Ölçü (mm) Dim. (mm)	Koli/Adet Pcs/Ctn
43030001	500x500x100	6



» Çatal Kaşık Basketi
Cutlery Rack

Kod Code	Ölçü (mm) Dim. (mm)	Koli/Adet Pcs/Ctn
43030002	500x500x100	6

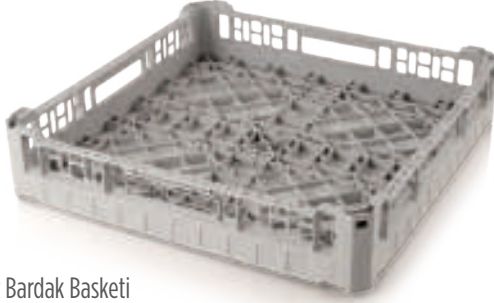
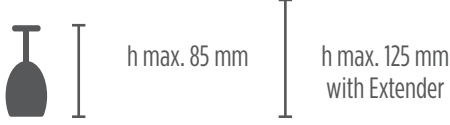

» Düz Bardak Basketi
Glass Rack

Kod Code	Ölçü (mm) Dim. (mm)	Koli/Adet Pcs/Ctn
43030003	500x500x100	6

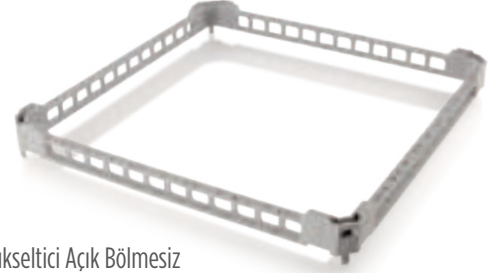

» Yükseltici Açık Bölmesiz
Open Extender

Kod Code	Ölçü (mm) Dim. (mm)	Koli/Adet Pcs/Ctn
43004006	500x500x40	10

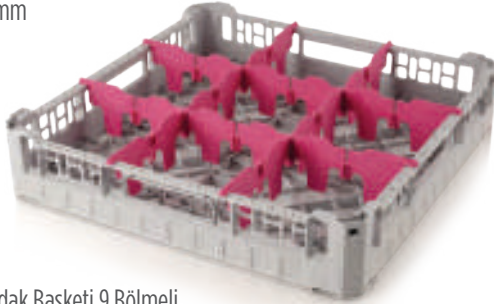

» Bardak Basketi 9 Bölmeli
9 Compartment Base

Kod Code	Ölçü (mm) Dim. (mm)	Koli/Adet Pcs/Ctn
43003009	500x500x100	6

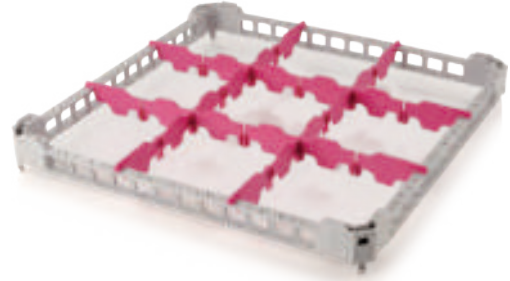

» Yükseltici 9 Bölmeli
9 Compartment Extender

Kod Code	Ölçü (mm) Dim. (mm)	Koli/Adet Pcs/Ctn
43004001	500x500x100	10

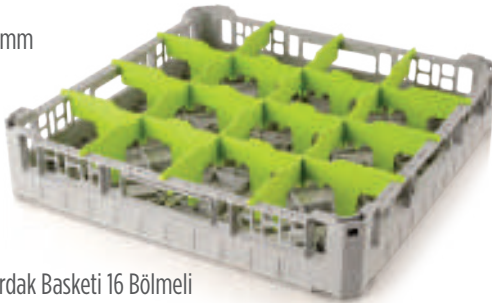
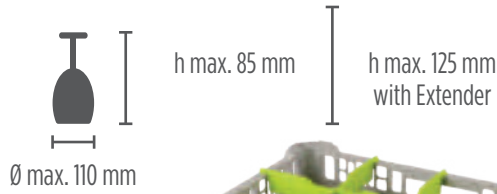

» Bardak Basketi 16 Bölmeli
16 Compartment Base

Kod Code	Ölçü (mm) Dim. (mm)	Koli/Adet Pcs/Ctn
43003016	500x500x100	6

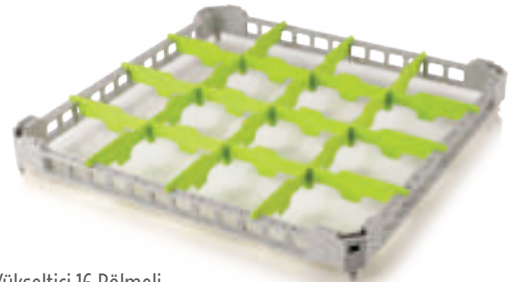

» Yükseltici 16 Bölmeli
16 Compartment Extender

Kod Code	Ölçü (mm) Dim. (mm)	Koli/Adet Pcs/Ctn
43004002	500x500x40	10

Basketler / Dishwasher Racks

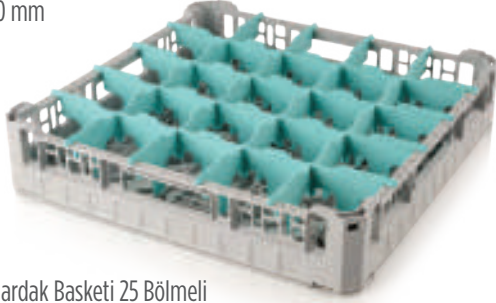

» Bardak Basketi 25 Bölme
25 Compartment Base

Kod Code	Ölçü (mm) Dim. (mm)	Koli/Adet Pcs/Ctn
43003025	500x500x100	6



» Yükseltici 25 Bölme
25 Compartment Extender

Kod Code	Ölçü (mm) Dim. (mm)	Koli/Adet Pcs/Ctn
43004003	500x500x40	10

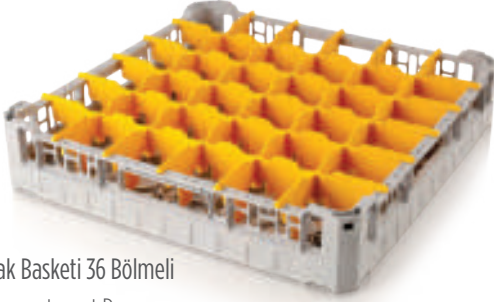
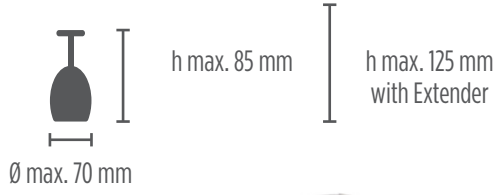

» Bardak Basketi 36 Bölme
36 Compartment Base

Kod Code	Ölçü (mm) Dim. (mm)	Koli/Adet Pcs/Ctn
43003036	500x500x100	6

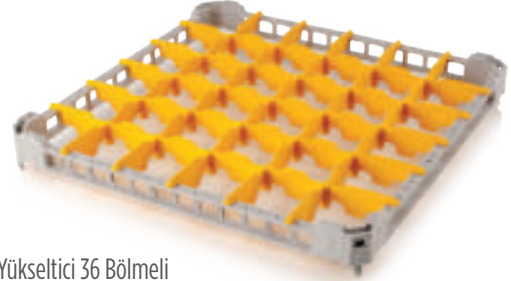

» Yükseltici 36 Bölme
36 Compartment Extender

Kod Code	Ölçü (mm) Dim. (mm)	Koli/Adet Pcs/Ctn
43004004	500x500x40	10

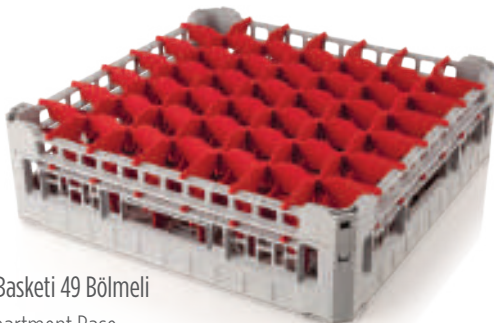
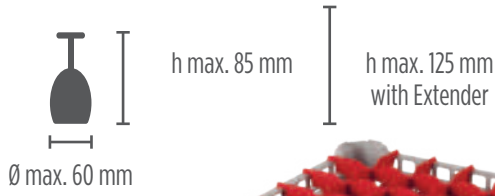

» Bardak Basketi 49 Bölme
49 Compartment Base

Kod Code	Ölçü (mm) Dim. (mm)	Koli/Adet Pcs/Ctn
43003049	500x500x100	6

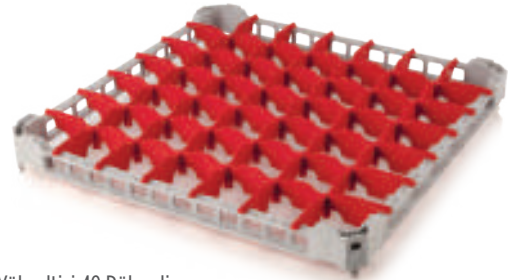

» Yükseltici 49 Bölme
49 Compartment Extender

Kod Code	Ölçü (mm) Dim. (mm)	Koli/Adet Pcs/Ctn
43004005	500x500x40	10

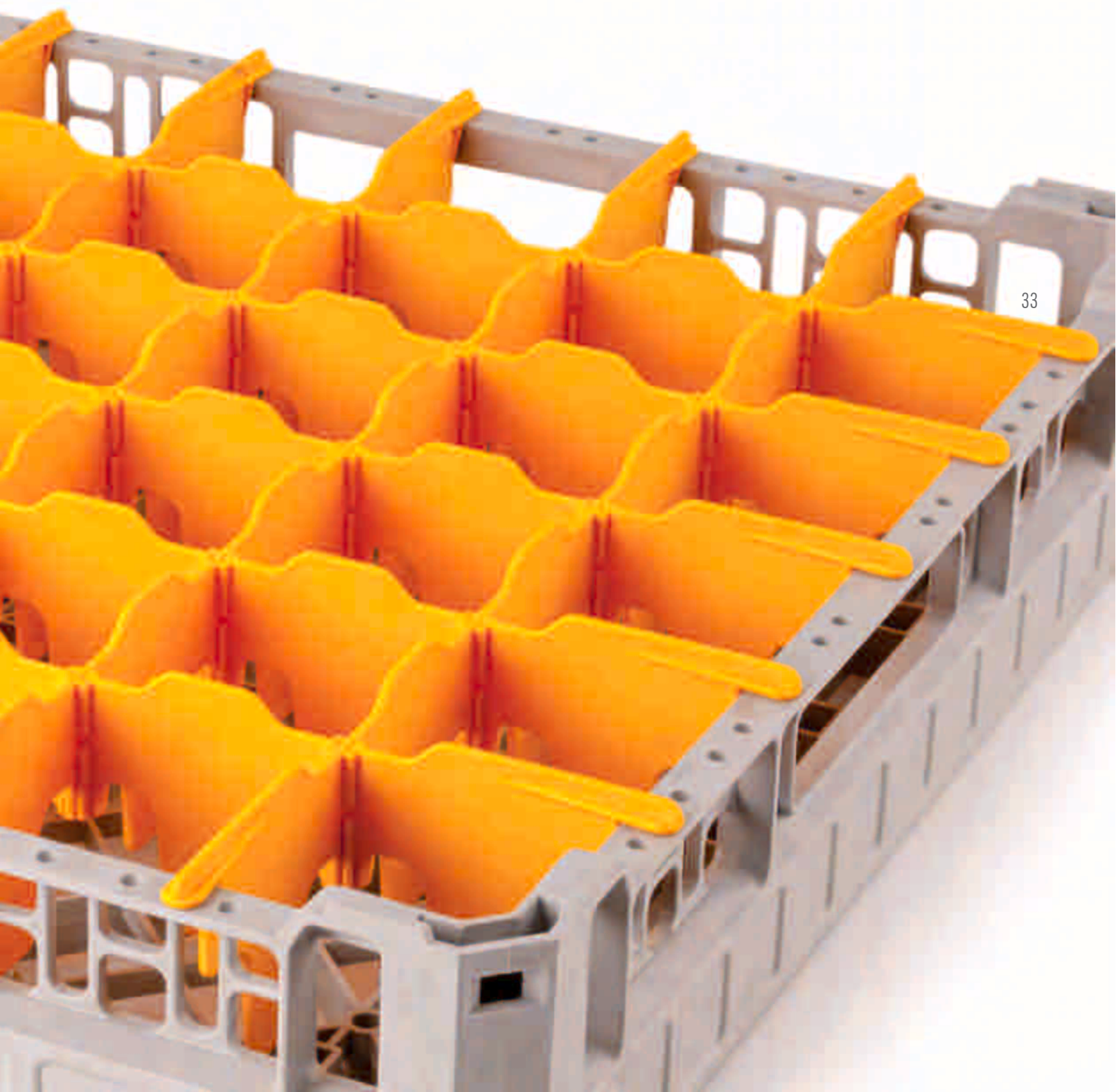

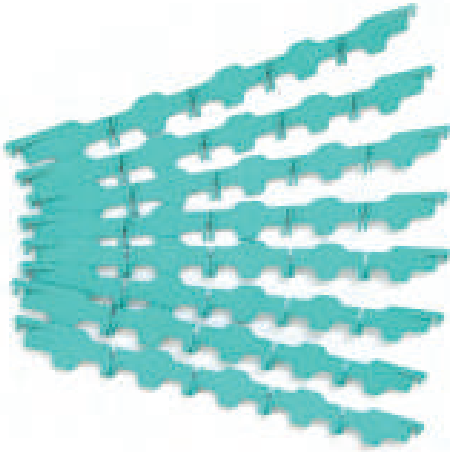

Nakliye esnasında avantaj sağlayan ayrı paketlenen iç bölmeler
1 Basket numerous separators easy stocking



Gövdeden ayrı iç bölmeler stok çeşidi bulundurma kolaylığı sağlar
1 Basket numerous separators easy stocking



Kolay takılabilir iç bölme panelleri
Easy hitchable separators



Kilit mekanizması takıldıktan sonra iç bölme panellerinin çıkmasını engeller
Locking mechanism for separator



Kolay takılıp çıkarılabilen yükseltici kilit mekanizması
Easy extender locking mechanism

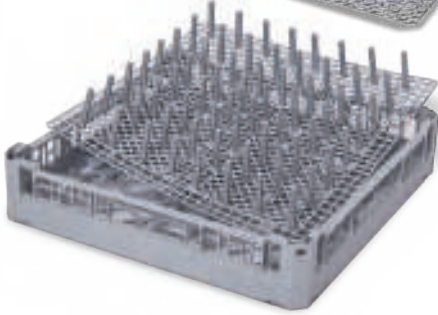
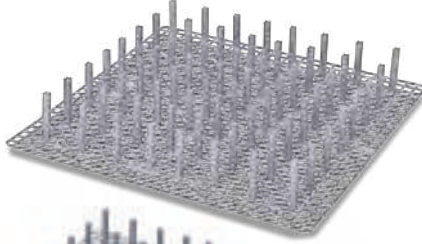

260

» Tabak Basketi Aparatı
Plate/Tray Rack Separator

Kod Code	Ölçü (mm) Dim. (mm)	Koli/Adet Pcs/Ctn
43130001	500x500x100	6

» Çatal Bıçak Basketi Aparatı
Cutlery Rack Separator

Kod Code	Ölçü (mm) Dim. (mm)	Koli/Adet Pcs/Ctn
43130002	500x500x40	10



» Bardak Basketi Aparatı 9 Bölmeli
9 Compartment Base Separator

Kod Code	Ölçü (mm) Dim. (mm)	Koli/Adet Pcs/Ctn
43003010	500x500x100	18



» Yükseltici Aparatı 9 Bölmeli
9 Compartment Extender Separator

Kod Code	Ölçü (mm) Dim. (mm)	Koli/Adet Pcs/Ctn
43004011	500x500x40	24

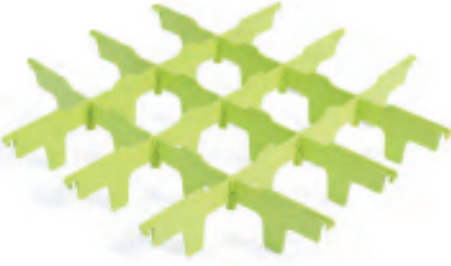

» Bardak Basketi Aparatı 16 Bölmeli
16 Compartment Base Separator

Kod Code	Ölçü (mm) Dim. (mm)	Koli/Adet Pcs/Ctn
43003017	500x500x100	18



» Yükseltici Aparatı 16 Bölmeli
16 Compartment Extender Separator

Kod Code	Ölçü (mm) Dim. (mm)	Koli/Adet Pcs/Ctn
43004012	500x500x100	18



» Bardak Basketi Aparatı 25 Bölmeli
25 Compartment Base Separator

Kod Code	Ölçü (mm) Dim. (mm)	Koli/Adet Pcs/Ctn
43004013	500x500x100	18



» Yükseltici Aparatı 25 Bölmeli
25 Compartment Extender Separator

Kod Code	Ölçü (mm) Dim. (mm)	Koli/Adet Pcs/Ctn
43004016	500x500x40	24



» Bardak Basketi Aparatı 36 Bölmeli
36 Compartment Base Extender

Kod Code	Ölçü (mm) Dim. (mm)	Koli/Adet Pcs/Ctn
43004014	500x500x40	18

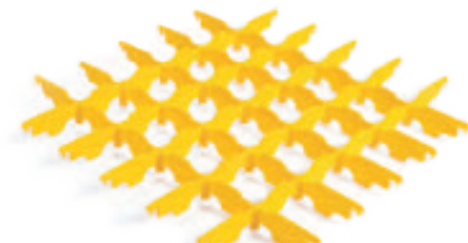

» Yükseltici Aparatı 36 Bölmeli
36 Compartment Extender Separator

Kod Code	Ölçü (mm) Dim. (mm)	Koli/Adet Pcs/Ctn
43004017	500x500x100	18



» Bardak Basketi Aparatı 49 Bölmeli
49 Compartment Base Separator

Kod Code	Ölçü (mm) Dim. (mm)	Koli/Adet Pcs/Ctn
43004015	500x500x100	18



» Yükseltici Aparatı 49 Bölmeli
49 Compartment Extender Separator

Kod Code	Ölçü (mm) Dim. (mm)	Koli/Adet Pcs/Ctn
43004018	500x500x40	24

Elektrikli Sinek Öldürücüler / Electrical Insect Killers

- Gerilim/Voltage : 220 - 230 V / 50 Hz
- Güç/UV Tube : 2x20 W
- Tesir alanı/Effective Range : 35-40 m²
- Deşarj Gerilimi/Discharge Voltage : 5000 V
- Ağırlık/Weight : 9,5 Kg
- Ölçü/Dimensions : 70x21,5x39 cm



» Sinek Öldürme Cihazı
Electrical Insect Killer

Kod Code	Güç Power	Koli/Adet Pcs/Ctn
67010001	2x20 W	1

- Gerilim/Voltage : 220 - 230 V / 50 Hz
- Güç/UV Tube : 2x40 W
- Tesir alanı/Effective Range : 55-60 m²
- Deşarj Gerilimi/Discharge Voltage : 5000 V
- Ağırlık/Weight : 9,5 Kg
- Ölçü/Dimensions : 70x21,5x39 cm



» Sinek Öldürme Cihazı
Electrical Insect Killer

Kod Code	Güç Power	Koli/Adet Pcs/Ctn
67010002	2x40 W	1

- Gerilim/Voltage : 220 - 230 V / 50 Hz
- Güç/UV Tube : 2x40 W
- Tesir alanı/Effective Range:100-110 m²
- Deşarj Gerilimi/Discharge Voltage: 5000 V
- Ağırlık/Weight: 13 Kg
- Ölçü/Dimensions : 127x21,5x39 cm



» Sinek Öldürme Cihazı
Electrical Insect Killer

Kod Code	Güç Power	Koli/Adet Pcs/Ctn
67010003	2x40 W	1

262

- Gerilim/Voltage :220 - 230 V / 50 Hz
- Güç/UV Tube : 2x40 W (Kısa Ampül)
- Tesir alanı/Effective Range :50 m²
- Ölçü/Dim. : 70x50x25 cm

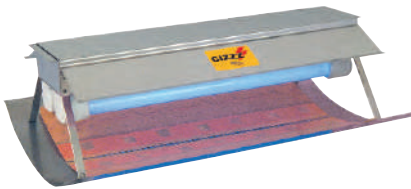

» Sinek Öldürme Cihazı Yapışkanlı
Electronic Insect Trap

Kod Code	Güç Power	Koli/Adet Pcs/Ctn
67010004	2x20 W	1

- Gerilim/Voltage : 220 - 230 V / 50 Hz
- Güç/UV Tube :2x40 W (Uzun Ampül)
- Tesir alanı/Effective Range : 100 m²
- Ölçü/Dim. : 125x50x25 cm

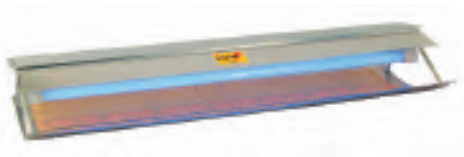

» Sinek Öldürme Cihazı Yapışkanlı
Electronic Insect Trap

Kod Code	Güç Power	Koli/Adet Pcs/Ctn
67010006	2x20 W	1

- Gerilim : 220 - 230 V / 50 Hz
- Güç : 2x40 W (Kısa Ampül)
- Tesir alanı : 50 m²
- Ölçü/Dim. : 62,5x31x21 cm

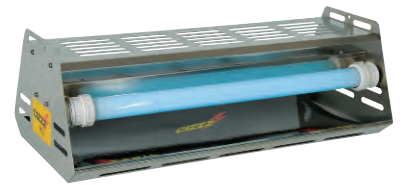

» Sinek Öldürme Cihazı Yapışkanlı
Electronic Insect Trap

Kod Code	Güç Power	Koli/Adet Pcs/Ctn
67010005	2x20 W	1



» Bulaşık Yıkama Duşu
Dish Washing

Kod Code	Model Model	Koli/Adet Pcs/Ctn
41030008	Klasik Tezgaha Monte/ Classic Counter-Mounted	1
41130008	Ara Musluklu Tezgaha Monte/ Mid-tap Counter-Mounted	1
41030011	Klasik Duvara Monte/ Classic Wall-Mounted	1
41130011	Ara Musluklu Duvara Monte/ Mid-tapWall-Mounted	1

» Geri Toplamalı Bulaşık Yıkama Duşu
Dish Washing Wall-Mounted

Kod Code	Model Model	Koli/Adet Pcs/Ctn
41030007	Klasik/ Classic	1
41030010	Ara Musluklu/ Mid-tap	1

» Evye
Sink

Kod Code	Ölçü (cm) Dim. (cm)	Koli/Adet Pcs/Ctn
30804425	40x40x25	5
30804525	40x50x25	5
30805525	50x50x25	5



» Tekerlekli Çöp Kovası
Rubbish Bin w/Wheels

Kod Code	Model Model	Øxh(cm) Øxh(cm)	Koli/Adet Pcs/Ctn
35524040	Kapaksız w/Wheel-w/o Lid	40x40	1
35524041	Kapaklı w/Wheel-w/Lid	40x40	1

» Saksılık
Pot w/o Bottom and w/o Handles

Kod Code	Øxh(cm) Øxh(cm)	Lt Lt	Koli/Adet Pcs/Ctn
35522400	24x28	12,5	2
35522800	28x28	17,2	2
35523200	32x32	26	1
35503600	36x36	36,6	1
35504000	40x40	50	1
35505000	50x50	100	1
35506000	60x55	155	1

» Rotil Ayak
Rotil Feet

Kod Code	Ölçü(cm) Dim(cm)	Koli/Adet Pcs/Ctn
46014055	40x55x115/181	200
46014040	40x40x93/151	250
46016060	Ø 60	100

ALFABETİK İNDEKS

A Açık Büfe Standları

Açık Büfe Yükselticiler
Ahşap Sunumluklar
Ananas Soyma

B Baharat Shaker

Bain Marie Küvetler
Bal Tokmağı (Polietilen)
Balık Pulu Temizleyicisi
Bar Ekipmanları
Bardaklar Polikarbonat
Basket Aparatları
Basketler
Bıçak Narenciye
Bıçak Rulosu
Bıçak Sterilizatörü
Bıçaklar
Bıçaklar Monoblok
Bıçaklar Perçinli
Bıçaklık Miknatıslı
Bıçaklık Miknatıslı
Blenderlar
Blenderlar
Bulaşık Yıkama
Buz Kırıcı
Buz Kırıcı
Buz Kovaları
Buz Makineleri
Buzlu İçecek Makinesi

C Carving Station

Çatal Monoblok
Çatal Servis
Çatal Servis
Çerezlikler
Chafing Dish (Classic Line)
Chafing Dish (Carina Line)
Chafing Dish (Delux Line)
Chafing Dish (Premium Line)
Chafing Dish (Vega Line)
Chafing Dish Economic
Chafing Dish Küvetler (Porselen)
Chafing Dish Standları
Çikolata Eritme Makinası
Çikolata Firkete Takımı
Çikolata Kalıpları
Çikolata Püskürtme Makinası
Çikolata Spatulası
Çin Külâhı
Çırpıcı
Çöp Kovası

D Değirmen Karabiber

Dekor Kaşık Seti

Derin Keççe
Dilimleyici Bıçaklar
Dişli Rulet
Dispenserler
Dispenserler
Dondurma Kaşığı
Dondurma Küvetleri
Dondurma Makinesi
Dondurmalı
Düdüklü Tencere
Duy Seti

E Ekmek Kesim

Ekmek Sepetleri
Ekmek Sepetleri
El Tipi Blenderlar
Eldivenler
Et Çengeli
Et döveceği
Et-Kemik Testeresi
Evye

F Fırın Tepsileri

Gıda Dilimleyici
Glasso Teli
GN Ekipmanları
GN Kapaklar
GN Küvetler
GN Küvetler Saplı
GN Küvetler Süzgeçli

H Hamburger Şekillendirici

Hamur Kazıyıcı
Hamur Kazıyıcı
Hardal Dispenseri
Hardal Şişesi
Havan (Polietilen)
Helvane Tencereler
Huni (Süzgeçli)

I İçecek Makineleri

İçecek Mikseri
İçecek Mikseri
İndüksiyon Ocaklar
İsimlik
İstif Rafı

J Japon Tornası

K Kabartma Kabı

Kaçarola
Kalbur
Kapaklar
Kanştırıcı Palet
Kaseler
Kaşık Monoblok
Kaşık Servis

Kaşık Servis

Kaşık Servis (PC)
Kaşık Seti Dekor
Kaşık Spagetti
Kaşık Standı
Kaşık Standı
Kayrak Sunumluklar
Kayrak Sunumluklar
Keççe (PC)
Keççe Monoblok
Keççe Standı
Keççeler
Keççeler
Kesim Levhaları
Kesim Levhası İstif Teli
Keççap Dispenseri
Keççap Şişesi
Kevgir
Kevgir
Kevgir
Kevgir Kaynaklı
Kevgir Monoblok
Kınlamaz Tepsiler
Kıvrın Küreği
Kızartma Örtüsü Çelik
Konik Süzgeç
Konserve Açacağı
Konserve Açacağı
Krema Torbası
Kruvasan Merdane
Küllükler
Küllükler
Kuskus Süzgeci
Küvetler (Polikarbonat)

L Le Rouet Gourmet

Levha Temizleme Bıçağı

M Makarna Pişirme Süzgeç

Makaslar
Mandalin Kesme
Maşa
Maşa (PC)
Maşa Silikon
Mayonez Dispenser
Mayonez Şişesi
Mikrodalga Fırın

N Narenciye Sıkacağı

Narenciye Sıkacağı

Ö Ölçek Seti

Ölçülü Kaplar
Önlük (Çelik)

O Oyacak

P Pandispanya Testeresi
Parizyen Kaşık
Paslanmaz Çelik Kalıplar
Pasta Bıçağı
Pasta Standı
Pataşu (Polietilen)
Patates Dilimleme
Patates Ezici
Patates Küreği
Peçetelikler
Peynir Dilimleyici
Peynir Rendeleyici
Pilav Ölçeği
Pişirme Tepsisi
Pizza Hamur Teknesi PP
Pizza Ruleti
Planet Mikser
Poli Merdane
Porselen GN Küvetler
Püre Makinesi
Pürmüz

R Raflar
Rendeler
Rulet

S Saklama Kapları (Polikarbonat)
Saklama Kapları (PP)
Şampanya & Şarap Kovaları
Sarımsak Ezici
Şaşula
Satırlar
Sebze Doğrayıcı
Sebze Doğrayıcı
Sebze Kurutucu
Şef Cimbızı
Şef Cimbızı
Sefer Tasları
Şekillendirici
Servis Arabaları
Servis Pilav
Servis Seti
Servis Üniteleri
Silikon Kalıplar
Silikon Kalıplar 40x60 cm
Silindirik Tencereler
Silpat Fiber Örtü
Sinek Öldürücüler
Sipariş Tutucu
Şiş
Sıcak Çikolata
Sıcak Tutucu Lambalar
Soda Sifonu

Soft Cooker
Sos Hunisi
Sos Şişesi Şeffaf
Sos Teknesi
Sos/Şurup Dökücü
Soyacak
Spatula Delikli
Spatula Servis Monoblok
Spatulalar
Spatulalar
Sunum Kapakları
Sunum Sandık & Sepetleri
Sunum Tepsileri
Sunumluklar
Süzgeç
Süzgeç Makarna

T Tabaklar PC
Taşıma Arabaları
Taşıma Kovaları
Taşıma Tepsisi
Tava Teli
Tavalar
Tavalar (Alüminyum Yapışmaz)
Tavalar Döküm
Tel Süzgeç
Tencere Teli
Tencereler Döküm
Tepsi Kırçılı
Tepsi Self Servis
Tepsi Servis
Tepsi Yuvarlak (S/S)
Tepsiler Kaydırmaz
Tepsiler Kaydırmaz
Tepsiler Kınılmaz
Teraziler
Tereyağ Çekici
Termometreler
Termos
Thermobox
Tuzluk & Karabiberlik

U Un Elek

V Vakumlu Paket Makinesi
Volovan

Y Yağlık & Sirkelik
Yanmaz Eldiven
Yapışmaz Kalıplar
Yükselticiler
Yumurta Çemberi

Z Zırh Çift Saplı
Zırhlar

ALPHABETICAL INDEX

A Appetizer Displays	203	Chocolate Spray Gun	98	Graters	68
Apron (S/S)	85	Citrus Juicer	189	Gravy Boat	179
Ashtrays	181	Citrus Juicer	237	H Hamburger Press	60
Ashtrays	205	Cleavers	84	Heat Retaining Lamps	152/153
B Bain Marie Containers	44	Colander	70	Honey Spoon (Polyethylene)	70
Baking Sheet	90	Colander Couscous	21	Hot Chocolate Dispenser	185
Baking Sheet Silicone	95	Colander Pasta	21	I Ice Buckets	198
Bar Equipments	201/202	Colander Pasta	71	Ice Cream Cup	179
Basket Seperator	261	Condiment Sets	177	Ice Cream Gn Pans	45
Beverage Mixer	188	Conical Strainer	71	Ice Cream Spoon	120
Beverage Mixer	236	Container w/Graduations (PC)	53	Ice Crusher	189
Blenders	187/188	Cooling Rack	98	Ice Crusher	238/239
Blenders	208//211	Corer	63	Ice Makers	190/191
Blenders	234/235	Cream Whipper	101	Ice Slush Dispenser	186
Board Scraper	76	Croissant Roller Cutter	103	Icing Tip Big Set	102
Bone Saw	226/227	Cutter	100	Induction Cookers	233
Bowls	165	Cutting Board Rack	76	Insect Killers	262
Bowls	179	Cutting Boards	76	Insulated Beverage Server	194
Bread Baskets	163	D Decor Spoon Set	69	J Juice Cooler	184/188
Bread Baskets	180	Decorator	63	K Ketchup Bottle	121
Bread Cutting Board	60	Discs	213	Ketchup Dispenser	121
Buffet Plates	154	Dish Washing	263	Knife Bag	79
Buffet Service Elevators	159	Dispensers	149/151	Knife Citrus	63
Buffet Service Stands	156/157	Dispensers	192/!93	Knife Sterilizer	85
Butter Curler	63	Display Boxes & Baskets	178	Knives	81/84
C Cake Stand	105	Display Covers	179	Knives Monoblock	80
Calibrated Cups	67	Display Trays	162	Knives Riveted	78
Can Opener	60	Dough Scraper	75	L Ladle (PC)	117
Can Opener	61	Dough Scraper	107	Ladle Monoblock	113
Carrying Containers	242	Dough Tray PP	45	Ladle Rest	146
Carrying Tray	243	E Egg Ring	68	Ladles	113
Carrying Trolleys	250/251	Extenders	258/261	Ladles	113
Carving Station	155	F Fish Scale Cleaner	70	Le Rouet Gourmet	56
Chafing Dish (Carina Line)	131/137	Food Mill	60	Lids	19
Chafing Dish (Classic Line)	145	Fork Monoblock	115	M Magnetic Board	79
Chafing Dish (Delux Line)	142/144	Fork Serving	115	Magnetic Board	85
Chafing Dish (Premium Line)	139/141	Fork Serving	115	Mandoline	56
Chafing Dish (Vega Line)	124/129	French Fries Shovel	120	Mayonnaise Bottle	121
Chafing Dish Economic	146	French Fry Cutter	57	Mayonnaise Dispenser	121
Chafing Dish Food Pans (Porcelain)	147	Funnel w/Strainer	71	Measuring Cup Set	67
Chafing Dish Stands	141	G Ganoese Saw	103	Meat Hook	85
Champagne & Wine Buckets	200	Garlic Press (S/S)	61	Meat Tenderiser	84
Cheese Grater	217	Glasses PC	195	Melon Baller	62
Cheese Slicer	61	Gloves	85	Microwave Oven	232
Chef's Tong	69	GN Equipments	47	Mill Salt&Pepper	173/175
Chef's Tong	119	GN Food Pan's Lids	42/43	Mincing Knife w/Double Hand	85
Chinese Colaner	71	GN Food Pans	36/37	Mincing Knives	84
Chocolate Dipping Forks	98	GN Food Pans Perforated	38/39	Mixing Spatula	69
Chocolate Melting Machine	98	GN Food Pans w/Handle	40/41	Mortar (Polyethylene)	70
Chocolate Moulds	96/97	Granita &Ice Slush Dispenser	186	Moulds Nonstick	88/90
Chocolate Spatula	98	Grate	70	Mustard Bottle	121

Mustard Dispenser	121
N Name Tag	146
Napkin Holders	179
O Oven Mitt	101
P Pans	23
Pans (Aluminum Non-Stick)	26
Pans (Polycarbonate)	50/51
Pastry Bags	102
Pastry Knife	75
Pastry Rollers	100
Pastry Wheel	62
Peeler	63
Pineapple Peeler	57
Pizza Roulette	75
Planet Mixer	224/225
Plates PC	171
Poli Roller	103
Porcelain GN Pans	46
Portable Food Containers	243
Potato Masher	69
Pots Cast Iron	27
Pouring Container	121
Pressure Cooker	11/12
R Racks	256/258
Rice Scoop	120
Roasteasy	30
Roasting Pans	31
Round Strainer	72
Round Strainer	72
Rubbish Bin	263
S Salad Spinner	55
Salt & Pepper	176
Sauce Bottle Transparent	121
Sauce Gun	68
Sauce Pan	25
Scales	66
Scissors	61
Scoop	69
Service Spoon	113
Service Trolleys	247/248
Serving Utensils	113/115
Shaker	71
Shelves	252/253
Sieve	70
Silicone Moulds	91/93
Silicone Moulds	94/95
Sink	263
Skewer	83
Skimmer	72
Skimmer	113
Skimmer	116

Skimmer	148
Skimmer Monoblock	113
Slate Display Plates	160/161
Slate Display Plates	168/169
Slicer	218/223
Soda Siphon	202
Soft Cooker	230/231
Spatula (Polyethylene)	69
Spatula Serving Monoblock	115
Spatulas	74/75
Spatulas	106/107
Spoon Monoblock	115
Spoon Rest	120
Spoon Rest	146
Spoon Serving	115
Spoon Serving	116
Spoon Serving (PC)	117
Spoon Set Decor	119
Spoon Spaghetti	116
Stainless Steel Moulds	99
Stock Pots	17/18
Storage Containers (PP)	54
Storing Shelf	76
Strainer For Pan	72
Strainer For Pot	72
T Table Crumbler	179
Tavayar Cast Iron	28/29
Tepsi Yuvarlak (S/S)	147
Thermobox	244/246
Thermometers	64/65
Tickets-Holder	69
Tong	117
Tong (PC)	117
Tong Silicone	117
Torch	102
Tray Self Service	112
Tray Serving	111
Tray Textured	110
Trays Non-slip	110
Trays Non-slip	204
Trays Unbreakable	110/111
Turner Perforated	116
Turning Slicer	56
U Unbreakable Displays	162
V Vacuum Packaging Machine	228
Vegetable Cutter	212
Vegetable Cutter	58/59
W Whisk	73
Wide Shallow Pots	20
Wooden Displays	170

W



29 Ekim Mah. Kusu Cad. No.11
Yazibasi 35875 Torbali-Izmir-TURKEY
Tel: +90 [850] 441 52 77 (pbx)
Fax: +90 [232] 853 74 75
www.kapp.com.tr
www.kapponline.com.tr
kapp@kapp.com.tr