

/// BRAVILOR BONAMAT

WHK

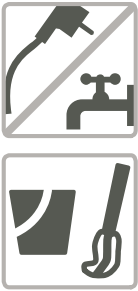

User manual
Mode d'emploi utilisateur
Gebraucher Handbuch
Gebruiksaanwijzing
Användarmanualen
Brukerhåndbok
Brugsanvisningen
Käyttäjän käsikirja
Manual del usuario
Manual do utilizador
Manuale per l'utente
Εγχειρίδιο χρήσης
Příručka pro uživatele
Podręcznik użytkownika
Manualul utilizatorului
Руководство
пользователя
Kullanıcı kilavuzu
使用手册
ユーザーマニュアル
사용자 설명서

700.403.742B



Model nr.: • WHK-003

www.bravilor.com

English
Français
Deutsch
Nederlands
Svenska



Norsk
Dansk
Suomi
Español
Português

Safety book
Sommaire des sécurités
Sicherheitsvorschriften
Veiligheidsboek
Säkerhetsföreskrifter



Sikkerhetsbok
Sikkerhedsbog
Turvallisuusohjeet
Libro de seguridad
Instruções de segurança

Installation
Installation
Installation
Installieren
Installation



Installasjon
Installation
Asennus
Instalar
Instalação

Cleaning
Nettoyage
Reinigung
Schoonmaken
Rengöring



Vasking
Rengøring
Puhdistus
Limpiar
Limpeza

Hot surface
Surface chaude
Heiße Oberfläche
Heet oppervlak
Het yta



Varm overflate
Varm overflade
Kuuma pinta
Superficie caliente
Superfície quente

Moist cloth
Chiffon humide
Feuchtes Tuch
Vochtige doek
Fuktig trasa



Fuktig klut
Fugtig klud
Kostea pyyhe
Trapo húmedo
Pano húmido

First read the safety instructions

Tout d'abord lire les mises en garde et directives de sécurité

Lesen Sie zuerst die Sicherheitsbestimmungen

Lees eerst de veiligheidsvoorschriften

Läs först säkerhetsinstruktionerna

Les først sikkerhetsinstruksjonene

Læs først sikkerhedsanvisningerne

Lue ensin turvaohjeet

Lea en primer lugar las instrucciones de seguridad

Leia em primeiro lugar as instruções de segurança

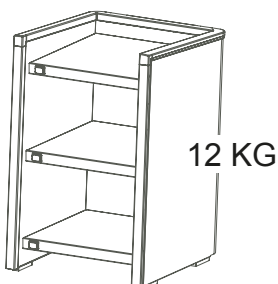

12 KG

Italiano
Ελληνικά
Česky
Polski
Română



Русский
Türkçe
中國語文
日本語
한국어

Prescrizioni di sicurezza
Εγχειρίδιο Ασφάλειας
Bezpečnostní kniha
Wskazówki
bezpieczeństwa
Carte instructaj



Руководство по безопасности
Güvenlik kitabı
安全手冊
安全マニュアル
안전 매뉴얼

Installazione
Εγκατάσταση
Instalace
Instalacja
Operare



Устанавливать
Yerleştirme
安裝
設置
설치

Pulizia
Καθάρισμα
Čištění
Czyszczenie
Curățare



Чистка
Temizleme
清潔的
クリーニング
청소

Superficie calda
Καυτή επιφάνεια
Horký ovrch
Gorąca powierzchnia
Suprafață fierbinte



Горячая поверхность
Sıcak yüzey
表面熱
溫液
뜨거운 표면

Panno umido
Υγρό πανί
Vlhká látka
Wilgotna szmatka
Cârpă umedă



Влажная салфетка
Nemli bez
潮濕的布
高温面
촉촉한 천

Leggere prima le norme di sicurezza

Διαβάστε πρώτα τις οδηγίες ασφαλείας

Nejprve si přečtete bezpečnostní pokyny

Najpierw zapoznaj się z instrukcjami bhp

Mai întâi citiți instrucțiunile de siguranță

Сначала прочитайте правила техники безопасности

Önce güvenlik talimatlarını okuyun

首先阅读安全须知

最初に安全上の注意をお読みください

먼저 안전 지침을 읽는다



1.



2.

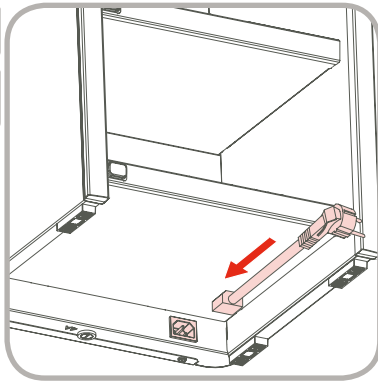

3.

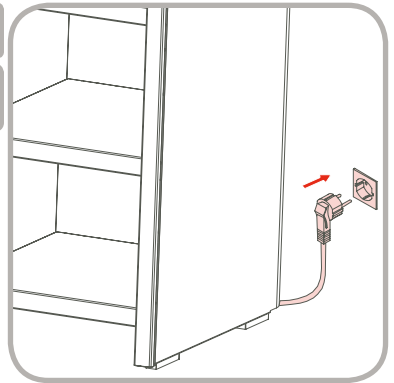

4.

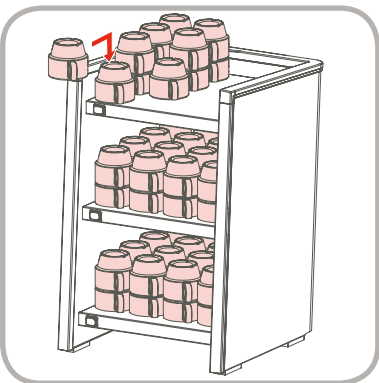

5.

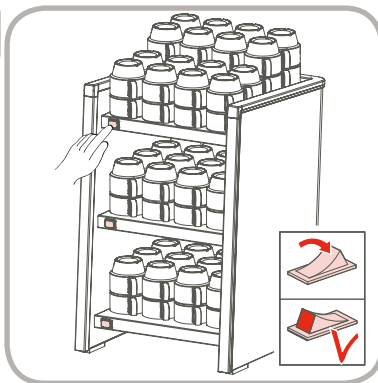

1.



2.

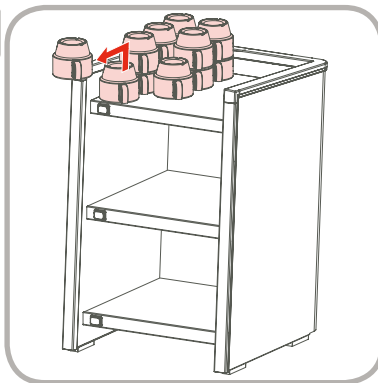

3.

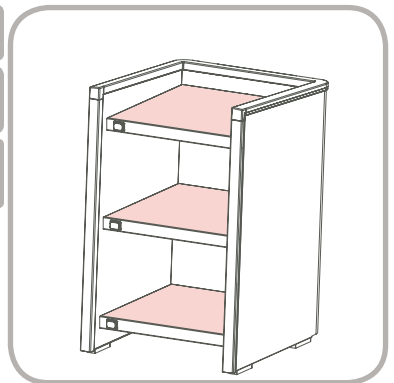

4.

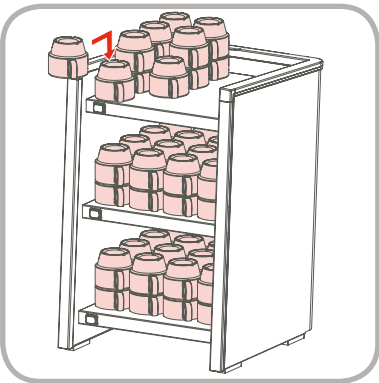

5.

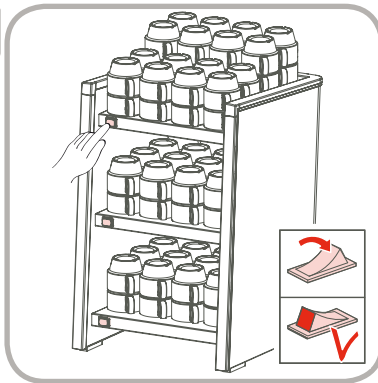



**/// BRAVILOR
BONAMAT**



©
05-2015
VHH

